

High Quality  
High Performance



**CATALOGUE  
2013**



# Contents

ADHESIVE TAPES.....	118	LED PROJECTORS .....	70
ALUMINIUM BULKHEAD LAMPS.....	71	LED STREET LAMPS .....	75
BALLASTS .....	112	LED STRIPS .....	96
CABLE TIES.....	118	LED TUBES .....	13
CEILING LAMPS.....	39	LIGHT CONTROL PHOTSENSORS.....	111
CONNECTOR .....	117	MAGNETIC WALL LAMPS .....	62
DECORATIVE CEILING LAMPS .....	36	MERCURY LAMPS.....	17
DESK LAMPS .....	53	METAL HALIDE LAMPS.....	18
DETECTOR .....	110	METAL HALIDE PROJECTORS.....	69
DOORBELLS.....	110	NAIL CABLE CLIPS.....	118
DOWNLIGHTS .....	32	NIGHT LAMPS.....	108
ELECTRONIC WALL LAMPS .....	57	PICTURE & MIRROR LAMPS.....	50
ENERGY SAVING LAMPS .....	2	PLASTIC FANS.....	120
EXHAUST FANS.....	119	RECHARGEABLE & EMERGENCY LANTERNS.....	102
FLOOR LAMPS .....	51	REFLECTOR BULBS.....	16
FLUORESCENT LOUVER FITTINGS .....	60	RGB CONTROLLERS.....	100
FLUORESCENT TUBES .....	8	RG6 COAXIAL CABLE.....	117
GARDEN LAMPS .....	76	ROPELIGHTS .....	101
HALOGEN DOWNLIGHTS.....	19	ROPELIGHT CONTROLLER .....	101
HALOGEN LAMPS .....	9	SENSORS .....	111
HALOGEN PROJECTORS .....	67	SOCKET.....	118
HIGH BAY LAMPS .....	64	SOLAR LAMPS.....	91
INCANDESCENT BULBS .....	14	SPOTLIGHTS .....	48
INGROUND & RECESSED TYPE LED LAMPS .....	92	STARTERS.....	117
LAMP HOLDERS.....	115	STREET LAMPS .....	74
LED DOWNLIGHTS .....	25	SWITCH WITH ROPE .....	117
LED DRIVERS.....	99	TERMINAL BLOCKS .....	118
LED HIGH BAY LAMPS .....	66	TRANSFORMERS .....	113
LED LAMPS.....	11	UTP CAT5E NETWORK CABLE.....	118
LED LOUVER FITTINGS .....	61	WATERPROOF LAMPS .....	63
LED PANEL.....	61	WATERPROOF LED DRIVERS .....	100



### HL 8311 NANO

3U T2.2  
11W E27

- 220-240V / 50-60Hz
- Average Life: 8000 Hrs
- 500 Lm
- 2700 K / 6400 K



### HL 8315 MINI

3U T2.8  
15W E27

- 220-240V / 50-60Hz
- Average Life: 8000 Hrs
- 750 Lm / 730 Lm
- 2700 K / 6400 K



## Energy Saving Lamps



### HL 8315

3U T3.8  
15W E27

- 220-240V / 50-60Hz
- Average Life: 8000 Hrs
- 740 Lm
- 2700 K / 6400 K



### HL 8320

3U T3.6  
20W E27

- 220-240V / 50-60Hz
- Average Life: 8000 Hrs
- 990 Lm
- 2700 K / 6400 K



### HL 8325

3U T3.6  
25W E27

- 220-240V / 50-60Hz
- Average Life: 8000 Hrs
- 1250 Lm / 1230 Lm
- 2700 K / 6400 K



### HL 8411 MINI

4U T2.8  
11W E27

- 220-240V / 50-60Hz
- Average Life: 8000 Hrs
- 530 Lm / 500 Lm
- 2700 K / 6400 K



### HL 8415 NANO

4U T2.2  
15W E27

- 220-240V / 50-60Hz
- Average Life: 8000 Hrs
- 690 Lm
- 2700 K / 6400 K



### HL 8420 MINI

4U T3  
20W E27

- 220-240V / 50-60Hz
- Average Life: 8000 Hrs
- 1000 Lm / 980 Lm
- 2700 K / 6400 K



### HL 8434

4U T3.6  
34W E27

- 220-240V / 50-60Hz
- Average Life: 8000 Hrs
- 1700 Lm / 1680 Lm
- 2700 K / 6400 K







### HL 8609 NANO

HALF SPIRAL T2.2  
9W E27

- 220-240V / 50-60Hz
- Average Life: 8000 Hrs
- 430 Lm
- 2700 K / 6400 K



### HL 8611 NANO

HALF SPIRAL T2.2  
11W E27

- 220-240V / 50-60Hz
- Average Life: 8000 Hrs
- 530 Lm
- 2700 K / 6400 K



### HL 8615 NANO

HALF SPIRAL T2.2  
15W E27

- 220-240V / 50-60Hz
- Average Life: 8000 Hrs
- 730 Lm
- 2700 K / 6400 K



### HL 8620 NANO

HALF SPIRAL T2.2  
20W E27

- 220-240V / 50-60Hz
- Average Life: 8000 Hrs
- 980 Lm
- 2700 K / 6400 K



### HL 8623 NANO

HALF SPIRAL T2.2  
23W E27

- 220-240V / 50-60Hz
- Average Life: 8000 Hrs
- 1135 Lm
- 2700 K / 6400 K



### HL 8615 MINI

HALF SPIRAL T2.8  
15W E27  
BLUE, RED,  
GREEN, YELLOW

- 220-240V / 50-60Hz
- Average Life: 8000 Hrs
- 76 Lm (Red)
- 80 Lm (Blue)
- 360 Lm (Green)
- 380 Lm (Yellow)



### HL 8609 MICRO E14

HALF SPIRAL T2.6  
9W E14

- 220-240V / 50-60Hz
- Average Life: 8000 Hrs
- 435 Lm / 425 Lm / 425 Lm
- 2700 K / 4200 K / 6400 K



### HL 8609 MICRO E27

HALF SPIRAL T2.6  
9W E27

- 220-240V / 50-60Hz
- Average Life: 8000 Hrs
- 435 Lm / 425 Lm / 425 Lm
- 2700 K / 4200 K / 6400 K



### HL 8611 MINI E14

HALF SPIRAL T3  
11W E14

- 220-240V / 50-60Hz
- Average Life: 8000 Hrs
- 580 Lm / 570 Lm / 560 Lm
- 2700 K / 4200 K / 6400 K



### HL 8611 MINI E27

HALF SPIRAL T3  
11W E27

- 220-240V / 50-60Hz
- Average Life: 8000 Hrs
- 580 Lm / 570 Lm / 560 Lm
- 2700 K / 4200 K / 6400 K





### HL 8615 MINI E14

HALF SPIRAL T3  
15W E14

- 220-240V / 50-60Hz
- Average Life: 8000 Hrs
- 770 Lm / 760 Lm / 750 Lm
- 2700 K / 4200 K / 6400 K



### HL 8615 MINI E27

HALF SPIRAL T3  
15W E27

- 220-240V / 50-60Hz
- Average Life: 8000 Hrs
- 770 Lm / 760 Lm / 750 Lm
- 2700 K / 4200 K / 6400 K



### HL 8620

HALF SPIRAL T3.5  
20W E27

- 220-240V / 50-60Hz
- Average Life: 8000 Hrs
- 1040 Lm / 1030 Lm / 1020 Lm
- 2700 K / 4200 K / 6400 K



### HL 8625

HALF SPIRAL T3.8  
25W E27

- 220-240V / 50-60Hz
- Average Life: 8000 Hrs
- 1290 Lm / 1280 Lm / 1270 Lm
- 2700 K / 4200 K / 6400 K



### HL 8809 NANO E14

FULL SPIRAL T2.2  
9W E14

- 220-240V / 50-60Hz
- Average Life: 8000 Hrs
- 400 Lm
- 2700 K / 6400 K



### HL 8809 NANO E27

FULL SPIRAL T2.2  
9W E27

- 220-240V / 50-60Hz
- Average Life: 8000 Hrs
- 400 Lm
- 2700 K / 6400 K



### HL 8809 NANO G9

FULL SPIRAL T2.2  
9W G9

- 220-240V / 50-60Hz
- Average Life: 8000 Hrs
- 400 Lm
- 2700 K / 6400 K



### HL 8809 NANO GU10

FULL SPIRAL T2.2  
9W GU10

- 220-240V / 50-60Hz
- Average Life: 8000 Hrs
- 400 Lm
- 2700 K / 6400 K



### HL 8809 MICRO E14

FULL SPIRAL T2.5  
9W E14

- 220-240V / 50-60Hz
- Average Life: 8000 Hrs
- 420 Lm / 400 Lm
- 2700 K / 6400 K



### HL 8809 MICRO E27

FULL SPIRAL T2.5  
9W E27

- 220-240V / 50-60Hz
- Average Life: 8000 Hrs
- 420 Lm / 400 Lm
- 2700 K / 6400 K





### HL 8811 MICRO E14

FULL SPIRAL T2.5  
11W E14

- 220-240V / 50-60Hz
- Average Life: 8000 Hrs
- 500 Lm / 490 Lm / 480 Lm
- 2700 K / 4200 K / 6400 K



### HL 8811 MICRO E27

FULL SPIRAL T2.5  
11W E27

- 220-240V / 50-60Hz
- Average Life: 8000 Hrs
- 500 Lm / 490 Lm / 480 Lm
- 2700 K / 4200 K / 6400 K



### HL 8811 MINI E14

FULL SPIRAL T2.8  
11W E14

- 220-240V / 50-60Hz
- Average Life: 8000 Hrs
- 550 Lm / 540 Lm / 530 Lm
- 2700 K / 4200 K / 6400 K



### HL 8811 MINI E27

FULL SPIRAL T2.8  
11W E27

- 220-240V / 50-60Hz
- Average Life: 8000 Hrs
- 550 Lm / 540 Lm / 530 Lm
- 2700 K / 4200 K / 6400 K



### HL 8815 MINI E14

FULL SPIRAL T2.8  
15W E14

- 220-240V / 50-60Hz
- Average Life: 8000 Hrs
- 740 Lm / 730 Lm / 720 Lm
- 2700 K / 4200 K / 6400 K



### HL 8815 MINI E27

FULL SPIRAL T2.8  
15W E27

- 220-240V / 50-60Hz
- Average Life: 8000 Hrs
- 740 Lm / 730 Lm / 720 Lm
- 2700 K / 4200 K / 6400 K



### HL 8820

FULL SPIRAL T3.6  
20W E27

- 220-240V / 50-60Hz
- Average Life: 8000 Hrs
- 1040 Lm / 1030 Lm / 1020 Lm
- 2700 K / 4200 K / 6400 K



### HL 8825

FULL SPIRAL T3.8  
25W E27

- 220-240V / 50-60Hz
- Average Life: 8000 Hrs
- 1270 Lm / 1260 Lm / 1250 Lm
- 2700 K / 4200 K / 6400 K



### HL 8845

FULL SPIRAL T4.4  
45W E27

- 220-240V / 50-60Hz
- Average Life: 8000 Hrs
- 2280 Lm
- 2700 K / 6400 K



### HL 8865

FULL SPIRAL T5.2  
65W E27

- 220-240V / 50-60Hz
- Average Life: 8000 Hrs
- 2620 Lm
- 2700 K / 6400 K





**HL 8885 E27**

FULL SPIRAL T5.5  
85W E27

- 220-240V / 50-60Hz
- Average Life: 8000 Hrs
- 4150 Lm
- 2700 K / 6400 K



**HL 88105 E27**

FULL SPIRAL T5.6  
105W E27

- 220-240V / 50-60Hz
- Average Life: 8000 Hrs
- 5150 Lm
- 2700 K / 6400 K



**HL 8885 E40**

FULL SPIRAL T5.6  
85W E40

- 220-240V / 50-60Hz
- Average Life: 8000 Hrs
- 4150 Lm
- 2700 K / 6400 K



**HL 88105 E40**

FULL SPIRAL T5.6  
105W E40

- 220-240V / 50-60Hz
- Average Life: 8000 Hrs
- 5150 Lm
- 2700 K / 6400 K



**HL 8105 E14**

CANDLE  
5W E14

- 220-240V / 50-60Hz
- Average Life: 8000 Hrs
- 115 Lm
- 2700 K / 6400 K



**HL 8105 E27**

CANDLE  
5W E27

- 220-240V / 50-60Hz
- Average Life: 8000 Hrs
- 115 Lm
- 2700 K / 6400 K



**HL 8711R G5.3**

11W G5.3

- 220-240V / 50-60Hz
- Average Life: 10.000-15.000 Hrs
- 230 Lm
- 6400 K



**HL 8711R GU10**

11W GU10

- 220-240V / 50-60Hz
- Average Life: 10.000-15.000 Hrs
- 230 Lm
- 6400 K



**HL 8711D GU10**

11W GU10

- 220-240V / 50-60Hz
- Average Life: 10.000-15.000 Hrs
- 280 Lm
- 6400 K



**HL 8711D G5.3**

11W G5.3

- 220-240V / 50-60Hz
- Average Life: 10.000-15.000 Hrs
- 280 Lm
- 6400 K







**HL 8109**

R50  
9W E14

- 220-240V / 50-60Hz
- Average Life: 6.000 Hrs
- 215 Lm
- 2700 K / 6400 K



**HL 8111**

R63  
11W E27

- 220-240V / 50-60Hz
- Average Life: 6.000 Hrs
- 202 Lm
- 2700 K / 6400 K



**HL 8113**

R80  
13W E27

- 220-240V / 50-60Hz
- Average Life: 6.000 Hrs
- 260 Lm
- 2700 K / 6400 K





**HL 8740**

40W

- 220-240V / 50-60Hz
- Average Life: 8.000 Hrs
- 2400 Lm
- 6400 K





**HL 8720**

20W

- 220-240V / 50-60Hz
- Average Life: 8.000 Hrs
- 1200 Lm
- 6400 K





**PL**

7W (290 Lm)  
9W (440 Lm)  
11W (520 Lm)

- 220-240V / 50-60Hz
- Average Life: 8.000 Hrs
- 2700 K / 6400 K





**PLC**

10W (470 Lm)  
13W (610 Lm)  
18W (850 Lm)  
26W (1200 Lm)

- 220-240V / 50-60Hz
- Average Life: 8.000 Hrs
- 2700 K / 6400 K





**T5 DAYLIGHT**

6W  
8W  
13W  
21W  
28W





**T5 BLB**

6W  
8W

**HOZ ELECTRIC**

**Fluorescent Tubes**





**T8 BLB**

18W  
36W

**T8 DAYLIGHT**

10W  
15W  
18W  
30W  
36W  
58W

**T8 COLOR**

18W  
36W

RED  
GREEN  
BLUE

**T5 CIRCLE**

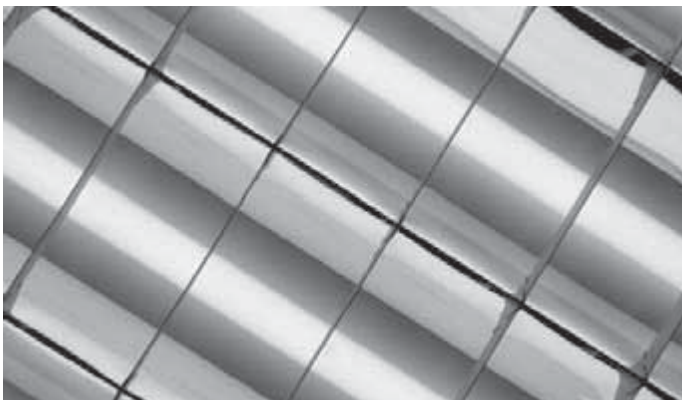
32W  
DAYLIGHT



**ADAPTER & T5 CIRCLE**

32W  
DAYLIGHT



**T9 CIRCLE**

32W  
DAYLIGHT





### MR11 OPEN

20W OPEN  
35W OPEN

● 220-240V / 50-60Hz



### MR11 OPEN

20W OPEN  
35W OPEN

● 12V



## Halogen Lamps



### MR11 CLOSED

20W CLOSED  
35W CLOSED

● 12V



### MR16 OPEN

20W OPEN  
35W OPEN  
50W OPEN

● 12V



### MR16 CLOSED

20W CLOSED  
35W CLOSED  
50W CLOSED

● 12V



### MR16 COLOR

50W CLOSED, RED  
50W CLOSED, BLUE  
50W CLOSED, GREEN  
50W CLOSED, YELLOW

● 12V



### JCDR OPEN

35W OPEN  
50W OPEN  
75W OPEN

● 220-240V / 50-60Hz



### JCDR CLOSED

35W CLOSED  
50W CLOSED  
75W CLOSED

● 220-240V / 50-60Hz



### GU10

35W  
50W

● 220-240V / 50-60Hz





**JC D G6.35**

35W  
50W  
75W

- 220-240V / 50-60Hz



**JC G6.35**

50W

- 12V



**JC G4**

10W  
20W  
35W

- 12V

**G9 FROST**

25W  
40W

- 220-240V / 50-60Hz



**JC G4 WHITE**

20W

- 12V



**G9 CLEAR**

25W  
40W

- 220-240V / 50-60Hz



**G9 WHITE**

25W  
40W

- 220-240V / 50-60Hz



**HALOGEN LAMPS**

- 220-240V / 50-60Hz



**254mm**  
1500W, 2000W

**189mm**  
1000W

**118mm**  
200W, 300W, 500W

**78mm**  
100W, 150W





○ WHITE 6400K  
 ○ COOL WHITE 4200K  
 ● RED  
 ● GREEN  
 ● BLUE  
 ● YELLOW



**JCDR POWER LED**

1x3W

- 220-240V / 50-60Hz
- Average Life: 60.000 - 80.000 Hrs



○ WHITE 6400K  
 ○ COOL WHITE 4200K  
 ● RED  
 ● GREEN  
 ● BLUE  
 ● YELLOW



**GU10 POWER LED**





1x3W

- 220-240V / 50-60Hz
- Average Life: 60.000 - 80.000 Hrs



**LED Lamps  
LED Tubes**

○ WHITE 6400K  
 ○ COOL WHITE 4200K  
 ● RED  
 ● GREEN  
 ● BLUE  
 ● YELLOW



**JDR POWER LED**

1x3W

- 220-240V / 50-60Hz
- Average Life: 60.000 - 80.000 Hrs



○ WHITE 6400K  
 ○ COOL WHITE 4200K  
 ● RED  
 ● GREEN  
 ● BLUE  
 ● YELLOW



**JDR POWER LED**

3x1W

- 220-240V / 50-60Hz
- Average Life: 60.000 - 80.000 Hrs



○ WHITE 6400K  
 ○ COOL WHITE 4200K  
 ● RED  
 ● GREEN  
 ● BLUE  
 ● YELLOW



**JCDR POWER LED**

3x1W

- 220-240V / 50-60Hz
- Average Life: 60.000 - 80.000 Hrs



○ WHITE 6400K  
 ○ COOL WHITE 4200K  
 ● RED  
 ● GREEN  
 ● BLUE  
 ● YELLOW



**GU10 POWER LED**

3x1W

- 220-240V / 50-60Hz
- Average Life: 60.000 - 80.000 Hrs



**COB LED**



**GU10 COB LED**

CLOSED  
3W  
5W

- 220-240V / 50-60Hz
- Average Life: 40.000 - 50.000 Hrs
- 6400K



○ WHITE 6400K  
 ○ COOL WHITE 4200K



**JCDR POWER LED**

5x1W

- 220-240V / 50-60Hz
- Average Life: 50.000 Hrs



○ WHITE 6400K  
 ○ COOL WHITE 4200K



**GU10 POWER LED**

5x1W

- 220-240V / 50-60Hz
- Average Life: 50.000 Hrs



 	<p><b>HL 436L</b></p> <p>2,5W</p> <ul style="list-style-type: none"> <li>● 220-240V / 50-60Hz</li> <li>● Average Life: 25.000 Hrs</li> <li>● 250 Lm</li> <li>● 4000 K</li> </ul> 	 	<p><b>HL 437L</b></p> <p>2,5W</p> <ul style="list-style-type: none"> <li>● 220-240V / 50-60Hz</li> <li>● Average Life: 25.000 Hrs</li> <li>● 250 Lm</li> <li>● 4000 K</li> </ul> 
 	<p><b>HL 438L E14</b></p> <p>2,5W</p> <ul style="list-style-type: none"> <li>● 220-240V / 50-60Hz</li> <li>● Average Life: 25.000 Hrs</li> <li>● 250 Lm</li> <li>● 4000 K</li> </ul> 	 	<p><b>HL 438L E27</b></p> <p>2,5W</p> <ul style="list-style-type: none"> <li>● 220-240V / 50-60Hz</li> <li>● Average Life: 25.000 Hrs</li> <li>● 250 Lm</li> <li>● 4000 K</li> </ul> 
 	<p><b>HL 439L</b></p> <p>5W</p> <ul style="list-style-type: none"> <li>● 220-240V / 50-60Hz</li> <li>● Average Life: 25.000 Hrs</li> <li>● 470 Lm</li> <li>● 4000 K</li> </ul> 	 	<p><b>HL 443L</b></p> <p>2,5W</p> <ul style="list-style-type: none"> <li>● 220-240V / 50-60Hz</li> <li>● Average Life: 25.000 Hrs</li> <li>● 250 Lm</li> <li>● 4000 K</li> </ul> 
 	<p><b>HL 444L</b></p> <p>5W</p> <ul style="list-style-type: none"> <li>● 220-240V / 50-60Hz</li> <li>● Average Life: 25.000 Hrs</li> <li>● 470 Lm</li> <li>● 4000 K</li> </ul> 	 	<p><b>HL 445L</b></p> <p>3W CLEAR</p> <ul style="list-style-type: none"> <li>● 220-240V / 50-60Hz</li> <li>● Average Life: 40.000 - 50.000 Hrs</li> <li>● 300 Lm</li> <li>● 2700K</li> </ul> 
 	<p><b>HL 446L</b></p> <p>3W FROSTED</p> <ul style="list-style-type: none"> <li>● 220-240V / 50-60Hz</li> <li>● Average Life: 40.000 - 50.000 Hrs</li> <li>● 300 Lm</li> <li>● 6400K</li> </ul> 	 	<p><b>HL 447L</b></p> <p>4W</p> <ul style="list-style-type: none"> <li>● 220-240V / 50-60Hz</li> <li>● Average Life: 40.000 - 50.000 Hrs</li> <li>● 400 Lm</li> <li>● 2700K / 6400K</li> </ul> 

**JCDR LED**

1.2W

- 220-240V / 50-60Hz
- Average Life: 60.0000 - 80.000 Hrs





**GU10 LED**

1.2W

- 220-240V / 50-60Hz
- Average Life: 60.0000 - 80.000 Hrs





**JDR LED**

1.2W

- 220-240V / 50-60Hz
- Average Life: 60.0000 - 80.000 Hrs







**SMD LED TUBE 60cm**

10W DAYLIGHT

- 220-240V / 50-60Hz
- Average Life: 50.000 Hrs
- 6400 K





**SMD LED TUBE 120cm**

19W DAYLIGHT

- 220-240V / 50-60Hz
- Average Life: 50.000 Hrs
- 6400 K





**HL 440L**

6W

- 220-240V / 50-60Hz
- Average Life: 20.000 Hrs
- 360 Lm





**HL 440L**

6W

- 220-240V / 50-60Hz
- Average Life: 20.000 Hrs
- 360 Lm





**NEW HL 448L**

1W

- 220-240V / 50-60Hz
- Average Life: 30.000 Hrs
- 2700K / 6400K





**NEW HL 449L**

2.5W

- 220-240V / 50-60Hz
- Average Life: 30.000 Hrs
- 2700K / 6400K







**HL 415**

MINI BULB  
10W  
CLEAR

- 220-240V / 50-60Hz
- Average Life: 1.000 Hrs



**HL 416**

MINI BULB  
10W  
CLEAR

- 220-240V / 50-60Hz
- Average Life: 1.000 Hrs



**Incandescent Bulbs**



**HL 417**

INDICATOR LAMP  
15W  
FROSTED

- 220-240V / 50-60Hz
- Average Life: 1.000 Hrs



**HL 420**

CANDLE BULB  
WITH TAIL  
40W, 60W  
CLEAR

- 220-240V / 50-60Hz
- Average Life: 1.000 Hrs



**HL 421**

CANDLE BULB  
WITH TAIL  
40W, 60W  
FROSTED

- 220-240V / 50-60Hz
- Average Life: 1.000 Hrs



**HL 423**

CANDLE BULB  
40W  
60W  
CLEAR

- 220-240V / 50-60Hz
- Average Life: 1.000 Hrs



**HL 424**

CANDLE BULB  
40W  
60W  
FROSTED

- 220-240V / 50-60Hz
- Average Life: 1.000 Hrs



**HL 425**

CANDLE BULB  
40W  
60W  
SOFT

- 220-240V / 50-60Hz
- Average Life: 1.000 Hrs



**HL 426**

SCREW CANDLE BULB  
40W  
60W  
FROSTED

- 220-240V / 50-60Hz
- Average Life: 1.000 Hrs







**HL 427**

SCREW CANDLE BULB  
40W  
60W  
CLEAR

- 220-240V / 50-60Hz
- Average Life: 1.000 Hrs



**HL 428**

CANDLE BULB  
40W  
60W  
FROSTED

- 220-240V / 50-60Hz
- Average Life: 1.000 Hrs



**HL 429**

CANDLE BULB  
40W  
60W  
SOFT

- 220-240V / 50-60Hz
- Average Life: 1.000 Hrs



**HL 430**

GLOBE BULB  
40W  
60W  
SOFT

- 220-240V / 50-60Hz
- Average Life: 1.000 Hrs



**HL 431**

GLOBE BULB  
40W  
60W  
FROSTED

- 220-240V / 50-60Hz
- Average Life: 1.000 Hrs



**HL 432**

GLOBE BULB  
40W  
60W  
SOFT

- 220-240V / 50-60Hz
- Average Life: 1.000 Hrs



**HL 433**

GLOBE BULB  
40W  
60W  
FROSTED

- 220-240V / 50-60Hz
- Average Life: 1.000 Hrs



**HL 434**

MUSHROOM BULB  
60W  
FROSTED

- 220-240V / 50-60Hz
- Average Life: 1.000 Hrs



**HL 435**

MUSHROOM BULB  
60W  
SOFT

- 220-240V / 50-60Hz
- Average Life: 1.000 Hrs





**R39**

30W  
FROSTED

- 220-240V / 50-60Hz
- Average Life: 1.000 Hrs



**R50**

40W  
60W  
FROSTED

- 220-240V / 50-60Hz
- Average Life: 1.000 Hrs



**HOZ** Reflector Bulbs  
ELECTRIC





**R63**

60W  
FROSTED

- 220-240V / 50-60Hz
- Average Life: 1.000 Hrs



**R80**

60W  
75W  
100W  
FROSTED

- 220-240V / 50-60Hz
- Average Life: 1.000 Hrs





### HL 400

HIGH PRESSURE  
MERCURY LAMP  
**125W**  
WITH BALLAST

● 220-240V / 50-60Hz



### HL 401

HIGH PRESSURE  
MERCURY LAMP  
**125W**

● 220-240V / 50-60Hz



## Mercury Lamps



### HL 402

HIGH PRESSURE  
MERCURY LAMP  
**160W**

● 220-240V / 50-60Hz



### HL 403

HIGH PRESSURE  
MERCURY LAMP  
**250W**  
WITH BALLAST

● 220-240V / 50-60Hz



### HL 404

HIGH PRESSURE  
MERCURY LAMP  
**250W**

● 220-240V / 50-60Hz



### HL 405

HIGH PRESSURE  
MERCURY LAMP  
**400W**  
WITH BALLAST

● 220-240V / 50-60Hz





**HL 406**

METAL HALIDE LAMP  
**150W**

● 220-240V / 50-60Hz



**HL 407**

METAL HALIDE LAMP  
**150W**

● 220-240V / 50-60Hz



**Metal Halide Lamps**

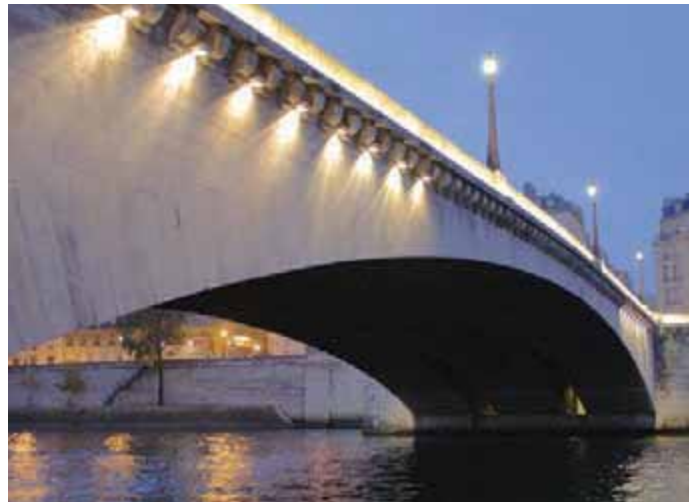

**HL 408**

METAL HALIDE LAMP  
**250W**

● 220-240V / 50-60Hz



**HL 409**

METAL HALIDE LAMP  
**250W**  
WHITE  
BLUE  
GREEN  
RED

● 220-240V / 50-60Hz



**HL 410**

METAL HALIDE LAMP  
**70W**

● 220-240V / 50-60Hz



**HL 411**

METAL HALIDE LAMP  
**150W**

● 220-240V / 50-60Hz





### HL 800

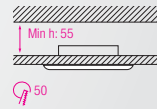
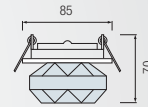
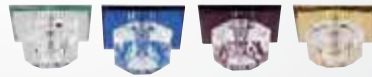

CLEAR  
BLUE  
YELLOW  
BROWN  
PURPLE

● 220-240V / 50-60Hz  
● Max. 20W



## Halogen Downlights



### HL 801

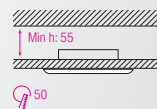
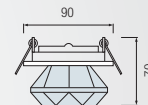
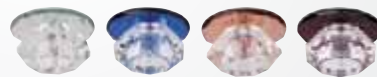

CLEAR  
BLUE  
YELLOW  
BROWN  
PURPLE

● 220-240V / 50-60Hz  
● Max. 20W

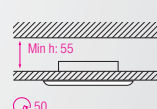
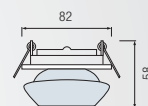

### HL 802

CLEAR  
BLUE  
YELLOW  
BROWN  
PURPLE

● 220-240V / 50-60Hz  
● Max. 20W



### HL 803

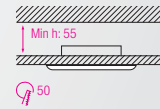
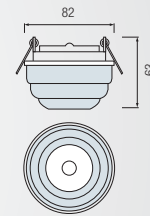

CLEAR  
BLUE  
YELLOW  
BROWN  
PURPLE

● 220-240V / 50-60Hz  
● Max. 20W



### HL 804

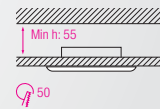
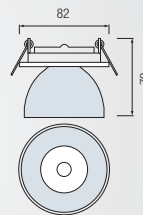
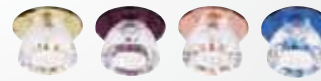

CLEAR  
BLUE  
YELLOW  
BROWN  
PURPLE

● 220-240V / 50-60Hz  
● Max. 20W



### HL 805

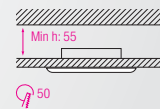
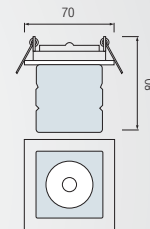

CLEAR  
BLUE  
YELLOW  
BROWN  
PURPLE

● 220-240V / 50-60Hz  
● Max. 20W



### HL 799

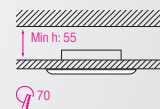
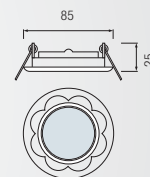
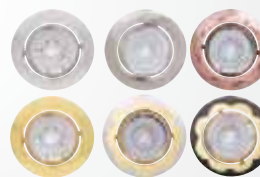

CHROME  
MAT CHROME  
GOLDEN  
ANTIQUE GREEN  
ANTIQUE RED COPPER  
TITANIUM BLACK/GOLDEN  
PEARL SILVER/GOLDEN

● 220-240V / 50-60Hz  
● Max. 50W



### HL 797

CHROME  
MAT CHROME  
GOLDEN  
ANTIQUÉ GREEN  
ANTIQUÉ RED COPPER  
TITANIUM BLACK/GOLDEN  
PEARL SILVER/GOLDEN

● 220-240V / 50-60Hz  
● Max. 50W

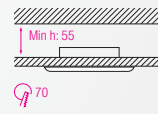
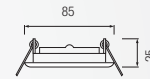
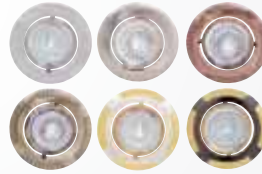

### HL 798

CHROME  
MAT CHROME  
GOLDEN  
ANTIQUÉ GREEN  
ANTIQUÉ RED COPPER  
TITANIUM BLACK/GOLDEN  
PEARL SILVER/GOLDEN

● 220-240V / 50-60Hz  
● Max. 50W

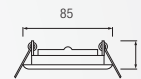



### HL 759

CHROME  
MAT CHROME  
GOLDEN  
ANTIQUÉ GREEN  
ANTIQUÉ RED COPPER  
TITANIUM BLACK/GOLDEN  
PEARL SILVER/GOLDEN

● 220-240V / 50-60Hz  
● Max. 50W

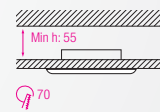
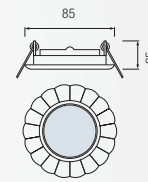
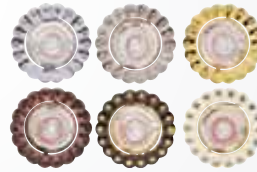

### HL 779

CHROME  
MAT CHROME  
GOLDEN  
ANTIQUÉ GREEN  
ANTIQUÉ RED COPPER  
TITANIUM BLACK/GOLDEN  
PEARL SILVER/GOLDEN

● 220-240V / 50-60Hz  
● Max. 50W

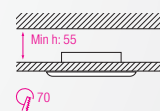
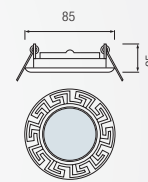

### HL 750

CHROME  
MAT CHROME  
GOLDEN  
WHITE

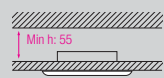

● 220-240V / 50-60Hz  
● Max. 50W

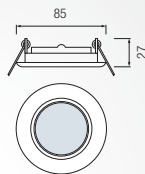

### HL 752

CHROME  
MAT CHROME  
GOLDEN  
RED COPPER  
PEARL CHROME  
WHITE

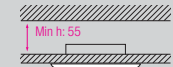

● 220-240V / 50-60Hz  
● Max. 50W

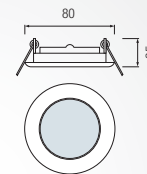

### HL 753

CHROME  
MAT CHROME  
GOLDEN  
WHITE



● 220-240V / 50-60Hz  
● Max. 50W

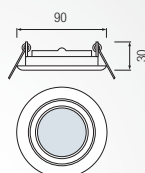

### HL 755

CHROME  
MAT CHROME  
GOLDEN



● 220-240V / 50-60Hz  
● Max. 50W

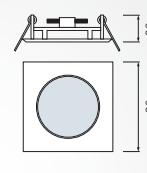



**HL 756**

CHROME  
MAT CHROME

Min h: 55

60

- 220-240V / 50-60Hz
- Max. 50W

MR16  
E27  
E26

F IP 44

**HL 760**

CHROME  
MAT CHROME  
GOLDEN

Min h: 55

50

- 220-240V / 50-60Hz
- Max. 20W

JC  
E27  
E26

F IP 20

**HL 761**

CHROME  
MAT CHROME  
GOLDEN

Min h: 50

55

- 220-240V / 50-60Hz
- Max. 20W

JC  
E27  
E26

F IP 20

**HL 762**

CHROME  
MAT CHROME  
GOLDEN

Min h: 55

50

- 220-240V / 50-60Hz
- Max. 20W

JC  
E27  
E26

F IP 20

**HL 763**

CHROME  
MAT CHROME

Min h: 55

45

- 220-240V / 50-60Hz
- Max. 20W

JC  
E27  
E26

F IP 20

**HL 764**

CHROME  
MAT CHROME

Min h: 55

45

- 220-240V / 50-60Hz
- Max. 20W

JC  
E27  
E26

F IP 20

**HL 765**

CHROME  
MAT CHROME  
GOLDEN

Min h: 40

20

- 220-240V / 50-60Hz
- Max. 20W

JC  
E27  
E26

F IP 20

**HL 766**

CHROME  
MAT CHROME  
GOLDEN  
WHITE

Min h: 50

25

- 220-240V / 50-60Hz
- Max. 20W

JC  
E27  
E26

F IP 20

**HL 767**

CHROME  
MAT CHROME  
GOLDEN

Min h: 40

20

● 220-240V / 50-60Hz  
● Max. 20W

JC  
64  
F  
IP 20

**HL 768**

CHROME  
MAT CHROME  
GOLDEN

Min h: 40

20

● 220-240V / 50-60Hz  
● Max. 20W

JC  
64  
F  
IP 20

**HL 769**

CLEAR  
BLUE  
PINK  
GREEN

136

Min h: 55

50

● 220-240V / 50-60Hz  
● Max. 50W

MR16  
65.3/68.35  
F  
IP 20

**HL 771**

GOLDEN  
SILVER  
TITANIUM BLACK

Min h: 55

55

● 220-240V / 50-60Hz  
● Max. 50W

MR16  
65.3/68.35  
F  
IP 20



**NEW** HL 666L

CHROME  
MAT CHROME

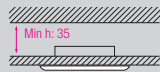

⌀ 33

- With Transformer
- 220-240V / 50-60Hz
- 2700K / 6400K
- 1x3W



- WHITE 6400K
- RED
- GREEN
- BLUE



HL 815L

MAT CHROME

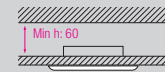
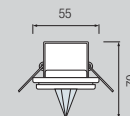

⌀ 40

- With Transformer
- 220-240V / 50-60Hz
- 1W



LED Downlights



COB LED



HL 678L - HL 679L

MAT CHROME

HL 678L - 3W 2700K / 6500K  
HL 679L - 5W 2700K / 6500K

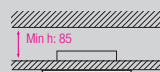
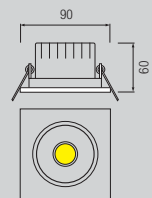

⌀ 75

- With Transformer
- AC 220-240V / 50-60Hz
- 2700K / 6500K



COB LED



HL 698L - HL 699L

MAT CHROME

HL 698L - 3W 2700K / 6500K  
HL 699L - 5W 2700K / 6500K

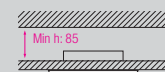
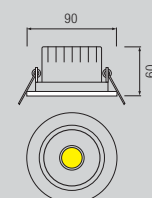

⌀ 75

- With Transformer
- AC 220-240V / 50-60Hz
- 2700K / 6500K







### HL 667L

RED+GREEN+BLUE+YELLOW

- With Transformer
- 220-240V / 50-60Hz
- 7x1W



### HL 668L

RED+GREEN+BLUE



- With Transformer
- 220-240V / 50-60Hz
- 3x1W



### HL 669L

RED+GREEN+BLUE+YELLOW

- With Transformer
- 220-240V / 50-60Hz
- 7x1W



- WHITE 6400K
- WARM WHITE 2700K



### HL 670L

MAT CHROME

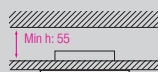
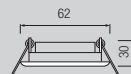

⌀ 60

- With Transformer
- AC 220-240V / 50-60Hz
- 1W



- WHITE 6400K
- WARM WHITE 2700K



### HL 671L

MAT CHROME

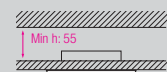
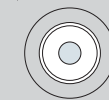
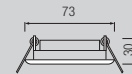

⌀ 60

- With Transformer
- AC 220-240V / 50-60Hz
- 1W





- WHITE 6400K
- WARM WHITE 2700K



### HL 672L

CHROME + MAT CAHROME

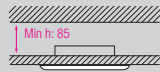
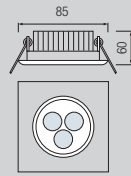

- With Transformer
- AC 220-240V / 50-60Hz
- 3W



- WHITE 6400K
- WARM WHITE 2700K



### HL 673L

CHROME + MAT CAHROME

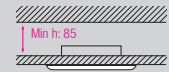
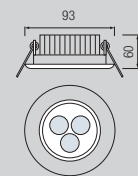

- With Transformer
- AC 220-240V / 50-60Hz
- 3W



- WHITE 6400K
- WARM WHITE 2700K



### HL 674L

CHROME + MAT CAHROME

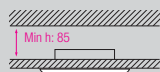
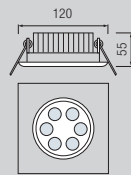

- With Transformer
- AC 220-240V / 50-60Hz
- 6W



- WHITE 6400K
- WARM WHITE 2700K



### HL 675L

CHROME + MAT CAHROME

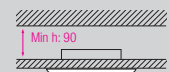
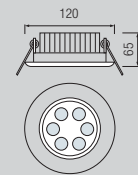

- With Transformer
- AC 220-240V / 50-60Hz
- 6W



- WHITE 6400K
- WARM WHITE 2700K

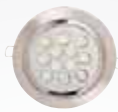

### HL 676L

CHROME + MAT CAHROME

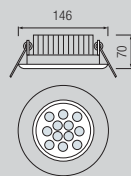

- With Transformer
- AC 220-240V / 50-60Hz
- 12W



- WHITE 6400K
- WARM WHITE 2700K



### HL 677L

CHROME + MAT CAHROME

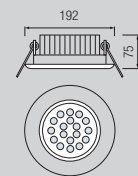

- With Transformer
- AC 220-240V / 50-60Hz
- 18W





○ WHITE 6400K  
● WARM WHITE 2700K

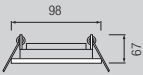

### HL 680L

MAT CHROME







Min h: 90

90x90

- With Transformer
- AC 220-240V / 50-60Hz
- 4W

POWERLED 4 pcs

○ WHITE 6400K  
● WARM WHITE 2700K



### HL 681L

MAT CHROME





Min h: 95

125x125

- With Transformer
- AC 220-240V / 50-60Hz
- 9W

POWERLED 9 pcs



○ WHITE 6400K  
● WARM WHITE 2700K



### HL 682L

MAT CHROME





Min h: 100

152x152

- With Transformer
- AC 220-240V / 50-60Hz
- 16W

POWERLED 16 pcs



○ WHITE 6400K  
● WARM WHITE 2700K



### HL 683L

MAT CHROME





Min h: 100

185x185

- With Transformer
- AC 220-240V / 50-60Hz
- 25W

POWERLED 25 pcs





**SMD LED**

○ WHITE 6000K  
● WARM WHITE 3000K



**HL 684L**  
WHITE  
MAT CHROME



● With Transformer  
● AC 220-240V / 50-60Hz  
● 6W

**SMD LED**    

**SMD LED**

○ WHITE 6000K  
● WARM WHITE 3000K



**HL 687L**  
WHITE  
MAT CHROME



● With Transformer  
● AC 220-240V / 50-60Hz  
● 6W

**SMD LED**    

**SMD LED**

○ WHITE 6000K  
● WARM WHITE 3000K



**HL 685L**  
WHITE  
MAT CHROME



● With Transformer  
● AC 220-240V / 50-60Hz  
● 12W

**SMD LED**    

**SMD LED**

○ WHITE 6000K  
● WARM WHITE 3000K



**HL 688L**  
WHITE  
MAT CHROME



● With Transformer  
● AC 220-240V / 50-60Hz  
● 12W

**SMD LED**    

**SMD LED**

○ WHITE 6000K  
● WARM WHITE 3000K



**HL 686L**  
WHITE  
MAT CHROME



● With Transformer  
● AC 220-240V / 50-60Hz  
● 15W

**SMD LED**    

**SMD LED**

○ WHITE 6000K  
● WARM WHITE 3000K



**HL 689L**  
WHITE  
MAT CHROME



● With Transformer  
● AC 220-240V / 50-60Hz  
● 15W

**SMD LED**    



- WHITE 6000K
- WARM WHITE 3000K



### HL 690L

WHITE  
MAT CHROME

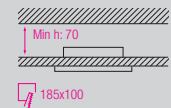
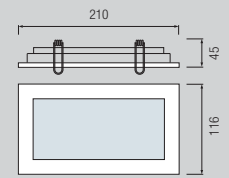

- With Transformer
- AC 220-240V / 50-60Hz
- 12W



- WHITE 6500K

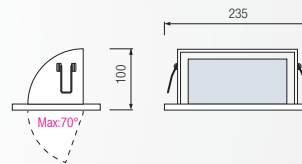

### HL 691L

WHITE

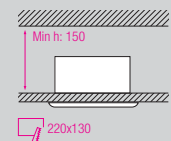

- With Transformer
- 220-240V / 50-60Hz
- Average Life: 40,000 Hrs
- 30W



- COOL WHITE 4200K



**NEW**

### HL 6978L 8 INCH

WHITE  
MAT CHROME

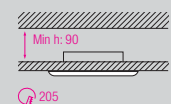
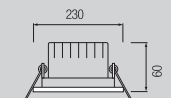

- 220-240V / 50-60Hz
- Average Life: 40,000 Hrs
- 30W





**HL 695L 3 INCH**

COB LED  
COOL WHITE 4200K



WHITE  
MAT CHROME



135  
70

Min h: 90  
120

- 220-240V / 50-60Hz
- Average Life: 40.000 Hrs
- 8W

COB LED F IP20

**HL 692L**

COB LED  
WHITE 6500K



WHITE



110  
85  
110

Min h: 110  
95

- With Transformer
- 220-240V / 50-60Hz
- Average Life: 40.000 Hrs
- 8W

COB LED F IP20

**HL 696L 4 INCH**

COB LED  
COOL WHITE 4200K



WHITE  
MAT CHROME



170  
85

Min h: 105  
155

- 220-240V / 50-60Hz
- Average Life: 40.000 Hrs
- 10W

COB LED F IP20

**HL 693L**

COB LED  
WHITE 6500K



WHITE



145  
120  
145

Min h: 150  
135

- With Transformer
- 220-240V / 50-60Hz
- Average Life: 40.000 Hrs
- 10W

COB LED F IP20

**HL 697L 6 INCH**

COB LED  
COOL WHITE 4200K



WHITE  
MAT CHROME



200  
100

Min h: 120  
180

- 220-240V / 50-60Hz
- Average Life: 40.000 Hrs
- 20W

COB LED F IP20

**HL 694L**

COB LED  
WHITE 6500K



WHITE



180  
150  
180

Min h: 180  
170

- With Transformer
- 220-240V / 50-60Hz
- Average Life: 40.000 Hrs
- 20W

COB LED F IP20

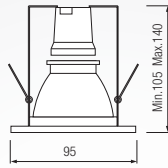

### HL 600 2,5" E27

CHROME  
MAT CHROME  
WHITE

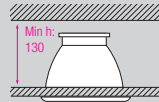

75

- 220-240V / 50-60Hz
- Max. 40W

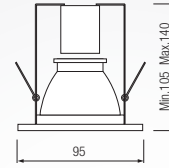

### HL 601 2,5" PLC

CHROME  
MAT CHROME  
WHITE



75

- 220-240V / 50-60Hz
- Max. 10W



## Downlights

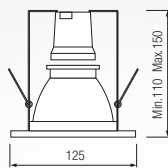

### HL 602 3" E27

CHROME  
MAT CHROME  
WHITE

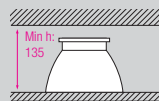

95

- 220-240V / 50-60Hz
- Max. 60W

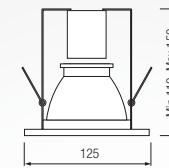

### HL 603 3" PLC

CHROME  
MAT CHROME  
WHITE



95

- 220-240V / 50-60Hz
- Max. 13W



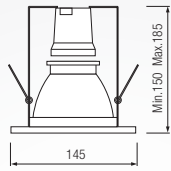

### HL 604 4" E27

CHROME  
MAT CHROME  
WHITE



- 220-240V / 50-60Hz
- Max. 60W

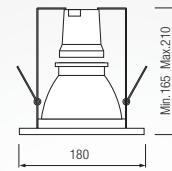

### HL 606 5" E27

CHROME  
MAT CHROME  
WHITE



- 220-240V / 50-60Hz
- Max. 75W

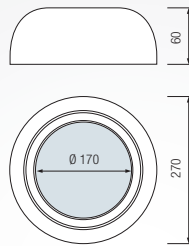

### HL 618 8" E27

CHROME  
MAT CHROME  
WHITE



- 220-240V / 50-60Hz
- Max. 2x20W

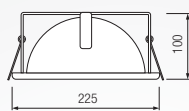

### HL 621 8" Rx7S

CHROME  
MAT CHROME  
WHITE

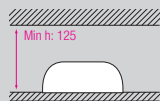

- 220-240V / 50-60Hz
- Max. 150W

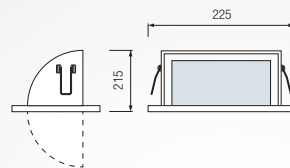

### HL 622

CHROME  
MAT CHROME  
WHITE

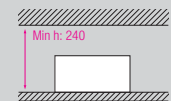

- 220-240V / 50-60Hz
- Max. 150W





**HL 610 6" PLC**

CHROME  
MAT CHROME  
WHITE

● 220-240V / 50-60Hz  
● Max. 2x18W

PLC  
E27  
F  
IP 20



**HL 611 6" E27**

CHROME  
MAT CHROME  
WHITE

● 220-240V / 50-60Hz  
● Max. 2x20W ESL

E27  
F  
IP 20



**HL 612 8" E27**

CHROME  
MAT CHROME  
WHITE

● 220-240V / 50-60Hz  
● Max. 2x26W ESL

E27  
F  
IP 20

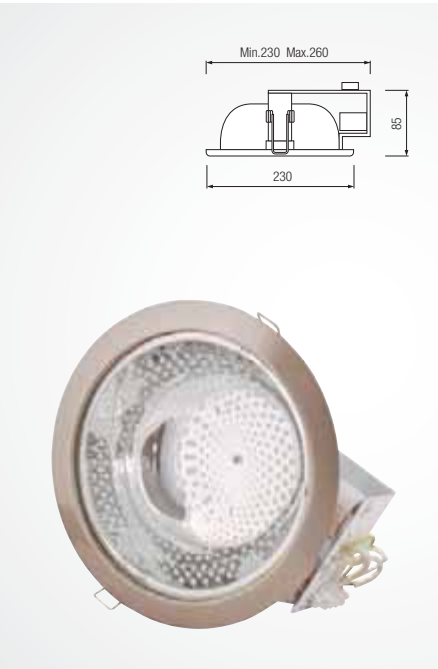

**HL 613 8" PLC**

CHROME  
MAT CHROME  
WHITE

● 220-240V / 50-60Hz  
● Max. 2x26W ESL

PLC  
E27  
F  
IP 20

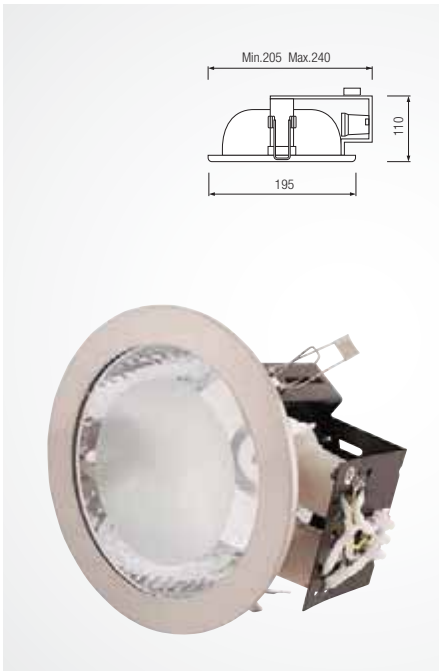

**HL 614 6" E27**

CHROME  
MAT CHROME  
WHITE

● 220-240V / 50-60Hz  
● Max. 2x20W ESL

E27  
F  
IP 20

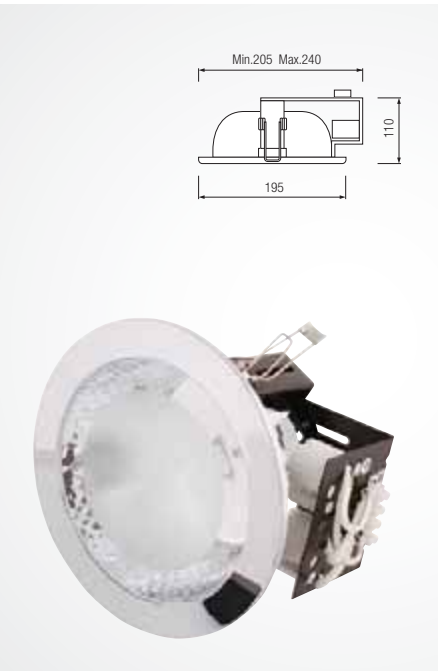

**HL 615 6" PLC**

CHROME  
MAT CHROME  
WHITE

● 220-240V / 50-60Hz  
● Max. 2x18W ESL

PLC  
E27  
F  
IP 20



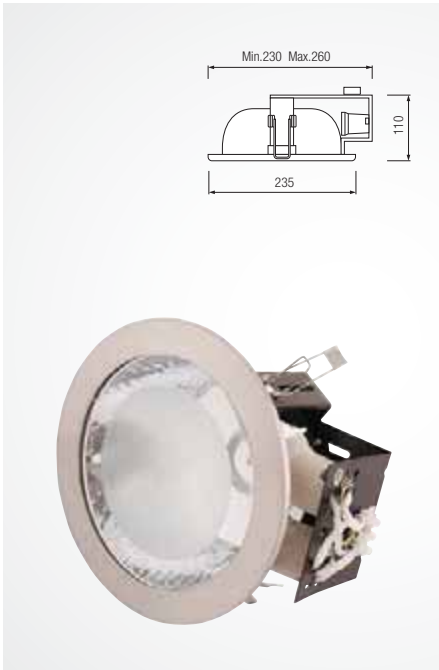

### HL 616 8" E27

CHROME  
MAT CHROME  
WHITE

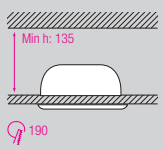

- 220-240V / 50-60Hz
- Max. 2x25W ESL

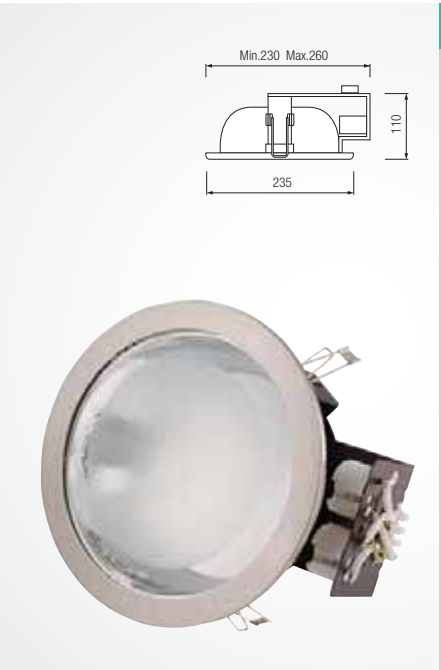

### HL 617 8" PLC

CHROME  
MAT CHROME  
WHITE

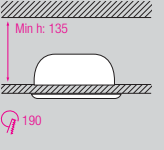

- 220-240V / 50-60Hz
- Max. 2x26W ESL

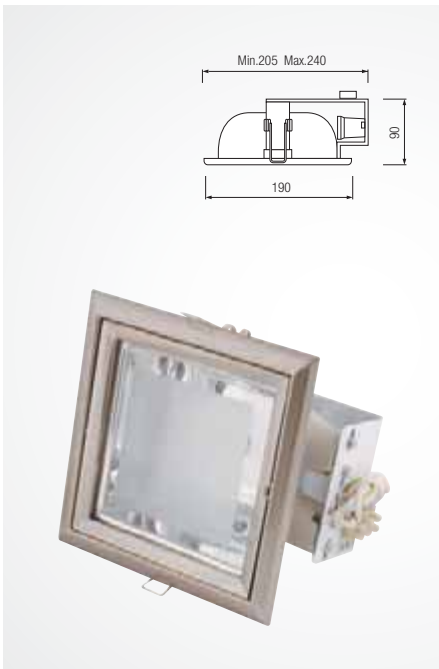

### HL 625 6" E27

CHROME  
MAT CHROME  
WHITE

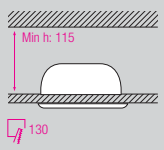

- 220-240V / 50-60Hz
- Max. 2x20W ESL



### HL 626 6" PLC

CHROME  
MAT CHROME  
WHITE

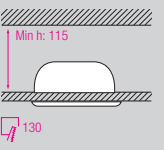

- 220-240V / 50-60Hz
- Max. 2x18W ESL



### HL 627 8" E27

CHROME  
MAT CHROME  
WHITE

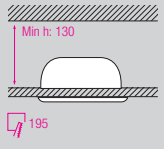

- 220-240V / 50-60Hz
- Max. 2x25W ESL



### HL 628 8" PLC

CHROME  
MAT CHROME  
WHITE

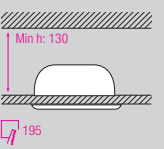

- 220-240V / 50-60Hz
- Max. 2x26W ESL





### HL 634S

CHROME + MAT CHROME  
Diffuser: Glass

- 220-240V / 50-60Hz
- Max. 60W
- Max. 11W ESL



### HL 634M

CHROME + MAT CHROME  
Diffuser: Glass

- 220-240V / 50-60Hz
- Max. 60W
- Max. 15W ESL



## Decorative Ceiling Lamps



### HL 634B

CHROME + MAT CHROME  
Diffuser: Glass

- 220-240V / 50-60Hz
- Max. 2x60W
- Max. 2x15W ESL



### HL 634W

CHROME + MAT CHROME  
Diffuser: Glass

- 220-240V / 50-60Hz
- Max. 60W
- Max. 15W ESL



### HL 635S

CHROME + MAT CHROME  
Diffuser: Glass

- 220-240V / 50-60Hz
- Max. 60W
- Max. 11W ESL



### HL 635M

CHROME + MAT CHROME  
Diffuser: Glass

- 220-240V / 50-60Hz
- Max. 60W
- Max. 15W ESL





### HL 635B

CHROME + MAT CHROME  
Diffuser: Glass

- 220-240V / 50-60Hz
- Max. 2x60W
- Max. 2x15W ESL



### HL 635W

CHROME + MAT CHROME  
Diffuser: Glass

- 220-240V / 50-60Hz
- Max. 60W
- Max. 15W ESL



### HL 636S

MAT CHROME  
Diffuser: Glass

- 220-240V / 50-60Hz
- Max. 60W
- Max. 15W ESL



### HL 636M

MAT CHROME  
Diffuser: Glass

- 220-240V / 50-60Hz
- Max. 2x60W
- Max. 2x15W ESL



### HL 636B

MAT CHROME  
Diffuser: Glass

- 220-240V / 50-60Hz
- Max. 3x60W
- Max. 3x15W ESL



### HL 636W

MAT CHROME  
Diffuser: Glass

- 220-240V / 50-60Hz
- Max. 60W
- Max. 15W ESL





**HL 640**  
MAT CHROME  
Diffuser: Glass

- 220-240V / 50-60Hz
- Max. 40W
- Max. 9W ESL



**HL 643**  
MAT CHROME  
Diffuser: Glass

- 220-240V / 50-60Hz
- Max. 40W
- Max. 11W ESL

   



**HL 641**  
MAT CHROME  
Diffuser: Glass





- 220-240V / 50-60Hz
- Max. 60W
- Max. 15W ESL



**HL 644**  
MAT CHROME  
Diffuser: Glass

- 220-240V / 50-60Hz
- Max. 60W
- Max. 15W ESL



**HL 642**  
MAT CHROME  
Diffuser: Glass

- 220-240V / 50-60Hz
- Max. 2x60W
- Max. 2x15W ESL



**HL 645**  
MAT CHROME  
Diffuser: Glass

- 220-240V / 50-60Hz
- Max. 2x60W
- Max. 2x15W ESL



**HL 637L**  
WHITE  
SILVER  
6400K

- With Transformer
- 220-240V / 50-60Hz
- Average Life: 40.000-50.000 Hrs
- 4x8W



### HL 790N

CHROME



- 220-240V / 50-60Hz
- 9W ESL



### HL 791N

CHROME



- 220-240V / 50-60Hz
- 2x9W ESL



Ceiling Lamps



### HL 792N

CHROME



- 220-240V / 50-60Hz
- Max. 3x9W ESL



### HL 793N

CHROME



- 220-240V / 50-60Hz
- 4x9W ESL



### HL 794N

CHROME



- 220-240V / 50-60Hz
- 3x9W ESL



### HL 785N

MAT CHROME



- 220-240V / 50-60Hz
- 9W ESL



### HL 786N

MAT CHROME



- 220-240V / 50-60Hz
- 2x9W ESL



### HL 787N

MAT CHROME



- 220-240V / 50-60Hz
- 3x9W ESL



### HL 788N

MAT CHROME



- 220-240V / 50-60Hz
- 4x9W ESL



### HL 715

CHROME



- 220-240V / 50-60Hz
- Max. 40W
- Max. 9W ESL



### HL 716

CHROME



- 220-240V / 50-60Hz
- Max. 2x40W
- Max. 2x9W ESL



### HL 717

CHROME



- 220-240V / 50-60Hz
- Max. 3x40W
- Max. 3x9W ESL



### HL 719

CHROME



- 220-240V / 50-60Hz
- Max. 3x40W
- Max. 3x9W ESL



### HL 718

CHROME



- 220-240V / 50-60Hz
- Max. 4x40W
- Max. 4x9W ESL





### HL 711

CHROME

- 220-240V / 50-60Hz
- Max. 40W



### HL 712

CHROME

- 220-240V / 50-60Hz
- Max. 2x40W



### HL 713

CHROME

- 220-240V / 50-60Hz
- Max. 3x40W



### HL 714

CHROME

- 220-240V / 50-60Hz
- Max. 4x40W





### HL 780

MAT CHROME



- 220-240V / 50-60Hz
- Max. 40W



### HL 781

MAT CHROME



- 220-240V / 50-60Hz
- Max. 2x40W



### HL 782

MAT CHROME



- 220-240V / 50-60Hz
- Max. 3x40W



### HL 784

MAT CHROME



- 220-240V / 50-60Hz
- Max. 3x40W



### HL 783

MAT CHROME



- 220-240V / 50-60Hz
- Max. 4x40W



### HL 743

MAT CHROME



- 220-240V / 50-60Hz
- Max. 40W



### HL 744

MAT CHROME



- 220-240V / 50-60Hz
- Max. 2x40W



### HL 745

MAT CHROME



- 220-240V / 50-60Hz
- Max. 3x40W





### HL 747

MAT CHROME



- 220-240V / 50-60Hz
- Max. 3x40W



### HL 746

MAT CHROME



- 220-240V / 50-60Hz
- Max. 4x40W



### HL 748

MAT CHROME



- 220-240V / 50-60Hz
- Max. 6x40W



### HL 700

CHROME+MAT CHROME



- 220-240V / 50-60Hz
- Max. 40W



### HL 701

CHROME+MAT CHROME



- 220-240V / 50-60Hz
- Max. 2x40W



### HL 702

CHROME+MAT CHROME



- 220-240V / 50-60Hz
- Max. 3x40W



### HL 703

CHROME+MAT CHROME



- 220-240V / 50-60Hz
- Max. 2x40W



### HL 704

CHROME+MAT CHROME



- 220-240V / 50-60Hz
- Max. 3x40W





### HL 705

GOLDEN+MAT GOLDEN



- 220-240V / 50-60Hz
- Max. 40W



### HL 706

GOLDEN+MAT GOLDEN



- 220-240V / 50-60Hz
- Max. 2x40W



### HL 707

GOLDEN+MAT GOLDEN



- 220-240V / 50-60Hz
- Max. 3x40W



### HL 708

GOLDEN+MAT GOLDEN



- 220-240V / 50-60Hz
- Max. 2x40W



### HL 709

GOLDEN+MAT GOLDEN



- 220-240V / 50-60Hz
- Max. 3x40W





### HL 720

CHROME  
MAT CHROME  
WHITE  
BLACK  
GOLDEN

- 220-240V / 50-60Hz
- Max. 40W



### HL 721

CHROME  
MAT CHROME  
WHITE  
BLACK  
GOLDEN

- 220-240V / 50-60Hz
- Max. 100W



## Spot Lights



### HL 722 WITH SWITCH

CHROME  
MAT CHROME  
WHITE  
BLACK  
GOLDEN

- 220-240V / 50-60Hz
- Max. 40W



### HL 723 WITH SWITCH

CHROME  
MAT CHROME  
WHITE  
BLACK  
GOLDEN

- 220-240V / 50-60Hz
- Max. 100W



### HL 724

CHROME  
MAT CHROME  
WHITE  
GOLDEN

- 220-240V / 50-60Hz
- Max. 2x40W



### HL 726

CHROME  
MAT CHROME  
WHITE  
GOLDEN

- 220-240V / 50-60Hz
- Max. 2x100W



### HL 725

CHROME  
MAT CHROME  
WHITE  
GOLDEN



- 220-240V / 50-60Hz
- Max. 3x40W



### HL 727

CHROME  
MAT CHROME  
WHITE  
GOLDEN



- 220-240V / 50-60Hz
- Max. 3x100W



### HL 728

CHROME  
MAT CHROME  
WHITE  
GOLDEN



- 220-240V / 50-60Hz
- Max. 2x40W



### HL 729

CHROME  
MAT CHROME  
WHITE  
GOLDEN



- 220-240V / 50-60Hz
- Max. 2x100W



### HL 730

CHROME  
MAT CHROME  
WHITE  
GOLDEN



- 220-240V / 50-60Hz
- Max. 3x40W



### HL 731

CHROME  
MAT CHROME  
WHITE  
GOLDEN



- 220-240V / 50-60Hz
- Max. 3x100W



**HL 003L**

RED  
WHITE  
BLACK

● 220-240V / 50-60Hz  
● 3W  
● 3000K

POWERLED  
1 pcs

□ F IP 20

**HL 008L**

RED  
WHITE  
BLACK

● 220-240V / 50-60Hz  
● 3W  
● 3000K

POWERLED  
1 pcs

□ F IP 20

**Picture & Mirror Lamps**

PCB  
RoHS

**HL 651**

CHROME  
MAT CHROME  
GOLDEN

● Built in electronic transformer  
● 220-240V / 50-60Hz **12V**  
● Max. 2x20W (JC)  
● Max. 2x35W (MR11)

JC MR11  
64 64

□ F IP 20

**HL 652**

CHROME  
MAT CHROME  
GOLDEN  
TITANIUM BLACK

● Built in electronic transformer  
● 220-240V / 50-60Hz **12V**  
● Max. 2x20W

JC  
64

□ F IP 20

**HL 653**

CHROME  
MAT CHROME  
GOLDEN  
MAT GOLDEN  
TITANIUM BLACK

● Built in electronic ballast  
● 220-240V / 50-60Hz  
● 8W

T4  
E14

□ F IP 20

**HL 654**

CHROME  
MAT CHROME  
GOLDEN  
MAT GOLDEN

● 220-240V / 50-60Hz  
● Max. 2x40W

G9

□ F IP 20

**HL 655**

CHROME  
MAT CHROME  
GOLDEN  
MAT GOLDEN

● 220-240V / 50-60Hz  
● Max. 2x25W

E14

□ F IP 20





## Floor Lamps



### HL 004L

RED  
WHITE  
BLACK

- 220-240V / 50-60Hz
- 3W
- 3000K



### HL 009L

RED  
WHITE  
BLACK

- 220-240V / 50-60Hz
- 3W
- 3000K



### HL 012L

RED  
WHITE  
BLACK

- 220-240V / 50-60Hz
- 3W
- 3000K







**HL 080**

WHITE  
BLUE  
GREEN  
ORANGE

- 220-240V / 50-60Hz
- Max. 100W

E27 □ F IP 20

Color selection icons:  
  
  

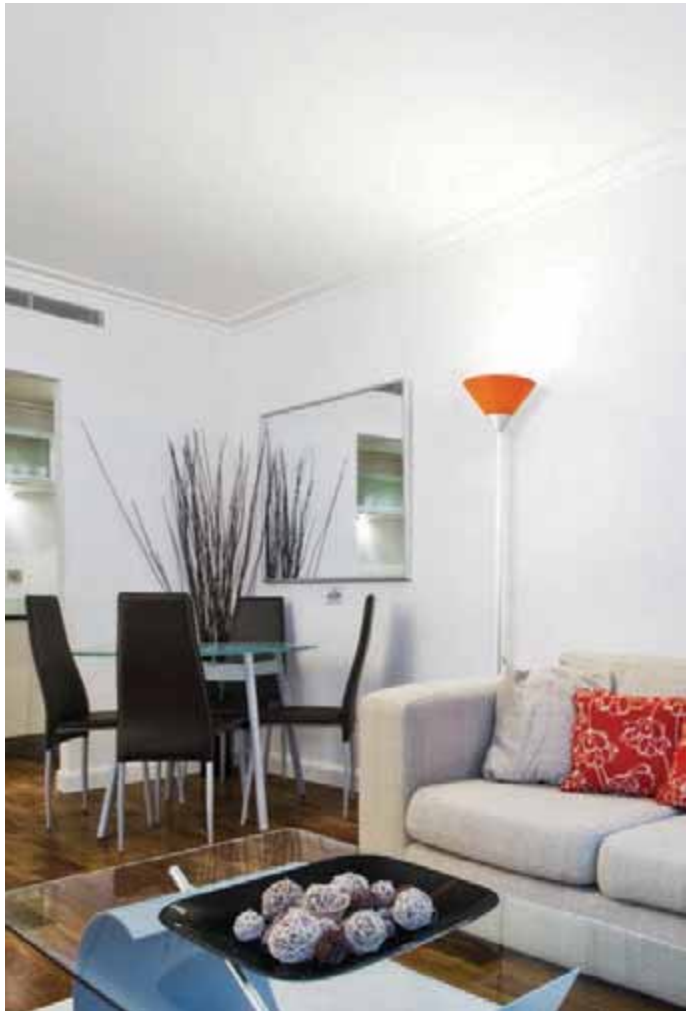



**HL 081**

WHITE

- 220-240V / 50-60Hz
- Mother: Max. 100W E27
- Baby: Max. 40W E14

E27 E14 □ F IP 20



**HL 082**

WHITE

- 220-240V / 50-60Hz
- Mother: Max. 100W E27
- Baby: Max. 40W E14

E27 E14 □ F IP 20



**HL 002L**

RED  
WHITE  
BLACK

- 220-240V / 50-60Hz
- 3W
- 3000K



**HOTOZ** Desk Lamps  
ELECTRIC



**HL 001L**

RED  
WHITE  
BLACK

- 220-240V / 50-60Hz
- 3W
- 3000K



**HL 006L**

RED  
WHITE  
BLACK

- 220-240V / 50-60Hz
- 3W
- 3000K



**HL 007L**

RED  
WHITE  
BLACK

- 220-240V / 50-60Hz
- 3W
- 3000K



**HL 011L**

RED  
WHITE  
BLACK

- 220-240V / 50-60Hz
- 3W
- 3000K



**NEW** HL 045

PINK  
BLUE  
YELLOW

● 220-240V / 50-60Hz  
● 15W  
● 5000K

G10q  
E27  
F  
IP 20

**NEW** HL 010L

BLACK  
WHITE  
BLUE  
RED

● 220-240V / 50-60Hz  
● 3W  
● 3000K

POWERLED  
E27  
F  
IP 20

**NEW** HL 046

YELLOW  
PINK  
WHITE

● 220-240V / 50-60Hz  
● 15W  
● 5000K

G10q  
E27  
F  
IP 20

**NEW** HL 013L

BLACK  
WHITE  
BLUE  
RED  
GREEN

● 220-240V / 50-60Hz  
● 3W  
● 3000K

POWERLED  
E27  
F  
IP 20

**NEW** HL 047

YELLOW  
ORANGE  
BLUE

● 220-240V / 50-60Hz  
● 15W  
● 5000K

G10q  
E27  
F  
IP 20

**NEW** HL 014L

BLACK  
WHITE  
BLUE  
RED  
GREEN

● 220-240V / 50-60Hz  
● 3W  
● 3000K

POWERLED  
E27  
F  
IP 20





**HL 028**

BLACK  
BLUE  
GREEN  
RED  
SILVER  
WHITE

● 220-240V / 50-60Hz  
● Max. 20W



**HL 036**

BLUE  
PINK  
GREEN

● 220-240V / 50-60Hz  
● Max. 11W



**HL 037**

BLUE  
PINK  
GREEN

● 220-240V / 50-60Hz  
● Max. 11W



**HL 038**

BLUE  
PINK  
YELLOW

● 220-240V / 50-60Hz  
● Max. 11W



**HL 039**

BLUE  
PINK  
YELLOW

● 220-240V / 50-60Hz  
● Max. 11W



**HL 043**

BLUE  
ORANGE  
GREEN

● 220-240V / 50-60Hz  
● Max. 11W



**HL 044**

BLUE  
PINK  
YELLOW

● 220-240V / 50-60Hz  
● Max. 11W



**HL 050**

BLACK  
WHITE  
RED  
BLUE

● 220-240V / 50-60Hz  
● Max. 60W





**HL 052**

CLEAR  
BLUE  
PURPLE  
GREEN  
ORANGE

- 220-240V / 50-60Hz
- Max. 40W







**HL 065**

BLACK  
BLUE  
GREEN  
RED  
WHITE

- 220-240V / 50-60Hz **12V**
- Max. 20W







**HL 067**

BLACK  
WHITE  
RED

- 220-240V / 50-60Hz
- Max. 60W







**HL 068**

BLACK  
WHITE  
RED

- 220-240V / 50-60Hz
- Max. 15W ESL
- Max. 40W









**HL 069**

BLACK  
WHITE  
RED  
GREY

- 220-240V / 50-60Hz
- Max. 11W









**HL 074**

BLACK  
WHITE  
RED

- 220-240V / 50-60Hz
- Max. 20W ESL
- Max. 60W









**HL 090**

GREEN  
BLUE

- 220-240V / 50-60Hz
- Max. 60W





### HL 2001

6W  
8W  
13W  
21W  
28W



● 220-240V / 50-60Hz



### HL 2002

8W  
13W  
21W  
28W

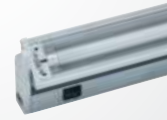

● 220-240V / 50-60Hz



## Electronic Wall Lamps



### HL 2004A

8W  
12W  
16W  
20W



● 220-240V / 50-60Hz



### HL 2004B

8W  
12W  
16W  
20W



● 220-240V / 50-60Hz



### HL 2004

8W  
13W



● 220-240V / 50-60Hz



### HL 2005

8W  
13W



● 220-240V / 50-60Hz



### HL 2006

8W  
13W



● 220-240V / 50-60Hz



### HL 2008

8W  
13W



● 220-240V / 50-60Hz



### HL 3011

10W  
15W  
18W  
30W  
36W



● 220-240V / 50-60Hz



### HL 3016

10W  
15W  
18W  
30W  
36W



● 220-240V / 50-60Hz



### HL 3013

18W  
36W



● 220-240V / 50-60Hz



### HL 3013R

18W  
36W



● 220-240V / 50-60Hz



### HL 3017

2x18W  
2x36W



● 220-240V / 50-60Hz



### HL 3017R

2x18W  
2x36W



● 220-240V / 50-60Hz





**HL 3020**

10W  
15W  
18W  
30W  
36W



● 220-240V / 50-60Hz

T8    

**HL 3021**

11W



● 220-240V / 50-60Hz

PL    



**HL 160 18W**  
**HL 161 36W**



● 220-240V / 50-60Hz

T8    

**HL 162 2x18W**  
**HL 163 2x36W**







● 220-240V / 50-60Hz

T8    

**HL 164 18W**  
**HL 165 36W**



● 220-240V / 50-60Hz

T8    

**HL 2007**

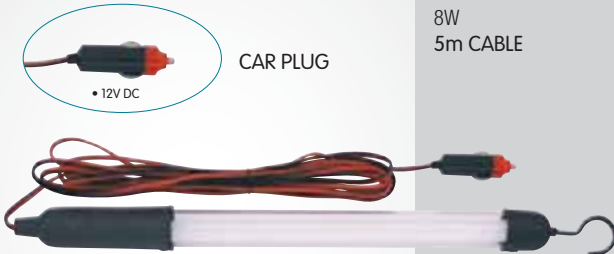

8W  
5m CABLE



● 220-240V / 50-60Hz  
● 12V DC

CAR PLUG 

EURO PLUG 

T5   

**HL 180 2x20W**  
**HL 184 2x40W**

RECESSED TYPE



- 220-240V / 50-60Hz
- With built-in suitable ballast & starter



**HL 182 4x20W**  
**HL 186 4x40W**

RECESSED TYPE



- 220-240V / 50-60Hz
- With built-in suitable ballast & starter



**Flourescent Louver Fittings**  
**LED Louver Fitting**  
**LED Panel**



**HL 181 2x20W**  
**HL 185 2x40W**

SURFACE TYPE



- 220-240V / 50-60Hz
- With built-in suitable ballast & starter



**HL 183 4x20W**  
**HL 187 4x40W**

SURFACE TYPE



- 220-240V / 50-60Hz
- With built-in suitable ballast & starter



SMD  
LED

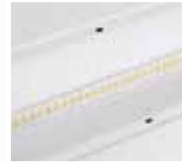

**NEW** HL 179L

WHITE

- 220-240V / 50-60Hz
- 36W
- 4200K / 6400K



SMD  
LED



**NEW** HL 975L

SILVER

- 220-240V / 50-60Hz
- 32W
- 3000K / 4200K / 6400K



HL 150



- 220-240V / 50-60Hz
- With built-in suitable ballast & starter
- Current: 0.37A
- ΔT65°C TW105°
- Max 20W



HL 152



- 220-240V / 50-60Hz
- With built-in suitable ballast & starter
- Current: 0.43A
- ΔT65°C TW105°
- Max 40W



### Magnetic Wall Lamps



HL 151



- 220-240V / 50-60Hz
- With built-in suitable ballast & starter
- Current: 0.41A
- ΔT65°C TW105°
- Max 2x20W

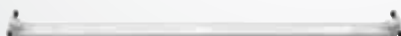

HL 153



- 220-240V / 50-60Hz
- With built-in suitable ballast & starter
- Current: 0.43A
- ΔT65°C TW105°
- Max 2x40W





### HL 140



- 220-240V / 50-60Hz
- With built-in suitable ballast
- Max. 11W



### HL 141



- 220-240V / 50-60Hz
- With built-in suitable ballast & starter
- Max. 20W



## Waterproof Lamps



### HL 142



- 220-240V / 50-60Hz
- With built-in suitable ballast & starter
- Max. 40W



### HL 143



- 220-240V / 50-60Hz
- With built-in suitable ballast & starter
- Max. 2x20W



### HL 144



- 220-240V / 50-60Hz
- With built-in suitable ballast & starter
- Max. 2x40W



**SHATTERPROOF**



**HL 500**

- 220-240V / 50-60Hz
- PC
- ø:180mm h:900mm
- Max. 40W
- Max. 15W ESL

E27, Grounding, F, IP20

**SHATTERPROOF**



**HL 502**

RED  
GREEN  
BLUE  
PINK  
CLEAR

- 220-240V / 50-60Hz
- PC
- ø:255mm h:1000mm
- Max. 40W
- Max. 25W ESL

E27, Grounding, F, IP20



**High Bay Lamps**  
**LED High Bay Lamps**

PC, RoHS



**SHATTERPROOF**



**HL 501**

- 220-240V / 50-60Hz
- PC
- ø:180mm h:900mm
- Max. 40W
- Max. 15W ESL

E27, Grounding, F, IP20

**SHATTERPROOF**



**HL 505**

- 220-240V / 50-60Hz
- PC
- ø:310mm h:950mm
- Max. 60W
- Max. 45W ESL

E27, Grounding, F, IP20

SHATTERPROOF



### HL 506

- 220-240V / 50-60Hz
- PC
- ø:315mm h:1000mm
- Max. 60W
- Max. 45W ESL



SHATTERPROOF



### HL 510

- 220-240V / 50-60Hz
- PC
- ø:355mm h:1000mm
- Max. 60W
- Max. 65W ESL



SHATTERPROOF



### HL 513

- 220-240V / 50-60Hz
- PC
- ø:413mm h:1000mm
- Max. 80W
- Max. 65W ESL



SHATTERPROOF



### HL 514

- 220-240V / 50-60Hz
- PC
- ø:413mm h:1100mm
- Max. 250W



COB  
LED

**NEW** HL 515L

- 220-240V / 50-60Hz
- Aluminium Body
- ø: 440mm h: 900mm
- 50W
- 6400K



COB  
LED

**NEW** HL 516L

- 220-240V / 50-60Hz
- Aluminium Body
- ø: 460mm h: 900mm
- 70W
- 6400K



COB  
LED

**NEW** HL 517L

- 220-240V / 50-60Hz
- Aluminium Body
- ø: 530mm h: 900mm
- 90W
- 6400K







### HL 100

WHITE  
BLACK



- 220-240V / 50-60Hz
- Max. 150W



### HL 101

WHITE  
BLACK



- 220-240V / 50-60Hz
- Max. 500W



## Halogen Projectors Metal Halide Projectors LED Projectors



### HL 102

WHITE  
BLACK



- 220-240V / 50-60Hz
- Max. 1000W



### HL 103

WHITE  
BLACK



- 220-240V / 50-60Hz
- Max. 1500W



### HL 104

WHITE  
BLACK



- 220-240V / 50-60Hz
- Max. 150W

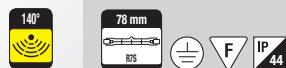

### HL 105

WHITE  
BLACK



- 220-240V / 50-60Hz
- Max. 500W

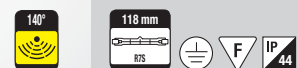



### HL 106

- 220-240V / 50-60Hz
- Max. 150W



### HL 107

- 220-240V / 50-60Hz
- Max. 500W



### HL 108

- 220-240V / 50-60Hz
- Max. 2x150W



### HL 109

- 220-240V / 50-60Hz
- Max. 500W



### HL 110

- 220-240V / 50-60Hz
- Max. 2x500W



INDOOR



### HL 115

WHITE  
BLACK  
SILVER

- 220-240V / 50-60Hz
- Max. 500W



**HL 120**

WHITE  
BLACK



- Built-in suitable ignitor, ballast
- 220-240V / 50-60Hz
- Max. 150W



**HL 120A**

WHITE  
BLACK



- 220-240V / 50-60Hz
- Max. 150W



**HL 131**



- Built-in suitable ignitor, ballast
- 220-240V / 50-60Hz
- Max. 400W



**HL 131A**



- 220-240V / 50-60Hz
- Max. 400W



**HL 135**

WHITE  
SILVER



- Built-in suitable ignitor, ballast, capacitor
- 220-240V / 50-60Hz
- Max. 150W



SMD  
LED

### HL 171L

BLACK  
SILVER

6500K

- 220-240V / 50-60Hz
- Average Life: 50.000 Hrs
- 10W



SMD  
LED

### HL 172L

BLACK  
SILVER

6500K

- 220-240V / 50-60Hz
- Average Life: 50.000 Hrs
- 30W



SMD  
LED

### HL 173L

BLACK  
SILVER

6500K

- 220-240V / 50-60Hz
- Average Life: 50.000 Hrs
- 50W





### HL 900

WHITE  
BLACK



● 220-240V / 50-60Hz  
● Max. 60W



### HL 901

WHITE  
BLACK



● 220-240V / 50-60Hz  
● Max. 60W



## Aluminium Bulkhead Lamps



### HL 902

WHITE  
BLACK



● 220-240V / 50-60Hz  
● Max. 60W



### HL 903

WHITE  
BLACK  
GREY



● 220-240V / 50-60Hz  
● Max. 60W



### HL 904

WHITE  
BLACK



● 220-240V / 50-60Hz  
● Max. 60W



### HL 905

WHITE  
BLACK



● 220-240V / 50-60Hz  
● Max. 60W



### HL 906

WHITE  
BLACK



● 220-240V / 50-60Hz  
● Max. 60W





**HL 907**

WHITE  
BLACK



● 220-240V / 50-60Hz  
● Max. 60W

E27    

**HL 908**

WHITE  
BLACK



● 220-240V / 50-60Hz  
● Max. 40W

E27    

**HL 909**

WHITE  
BLACK



● 220-240V / 50-60Hz  
● Max. 60W

E27    

**HL 910**

WHITE  
BLACK



● 220-240V / 50-60Hz  
● Max. 60W

E27    

**HL 911**

WHITE  
BLACK



● 220-240V / 50-60Hz  
● Max. 60W

E27    

**HL 920**

WHITE  
BLACK



● 220-240V / 50-60Hz  
● Max. 100W

E27    



**HL 921**

WHITE  
BLACK



● 220-240V / 50-60Hz  
● Max. 100W

E27    

### HL 925

WHITE  
BLACK



- 220-240V / 50-60Hz
- Max. 100W



### HL 926

WHITE  
BLACK



- 220-240V / 50-60Hz
- Max. 100W



### HL 930

WHITE  
BLACK  
MAT GREY



- 220-240V / 50-60Hz
- Max. 60W





**HL 191**  
BLACK

- 220-240V / 50-60Hz
- Max. 125W

E27, Grounding, F, IP 65



**HL 192**  
BLACK

- 220-240V / 50-60Hz
- Max. 250W

E40, Grounding, F, IP 65



**Street Lamps**  
**LED Street Lamps**

PCB, RoHS, CE, Energy Star



**HL 190**  
WHITE

- 220-240V / 50-60Hz
- Max. 60W
- Max. 20W ESL

E27, E27, Grounding, F, IP 65



COB  
LED



**NEW** HL 193L

SILVER

- 220-240V / 50-60Hz
- 6400K
- 1x30W



COB  
LED



**NEW** HL 194L

SILVER

- 220-240V / 50-60Hz
- 6400K
- 4x15W





**HL 295**  
BLACK

- 220-240V / 50-60Hz
- Stainless Steel and Galvanized Steel Body
- Diffuser: PC
- Max 100W
- Max 20W ESL

E27 E27

**HL 296**  
BLACK

- 220-240V / 50-60Hz
- Stainless Steel and Galvanized Steel Body
- Diffuser: PC
- Max 100W
- Max 20W ESL

E27 E27

**Garden Lamps**



**HL 297**  
BLACK

- 220-240V / 50-60Hz
- Stainless Steel and Galvanized Steel Body
- Diffuser: PC
- Max 100W
- Max 20W ESL

E27 E27

**HL 298**  
BLACK

- 220-240V / 50-60Hz
- Stainless Steel and Galvanized Steel Body
- Diffuser: PC
- Max 100W
- Max 20W ESL

E27 E27

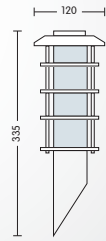
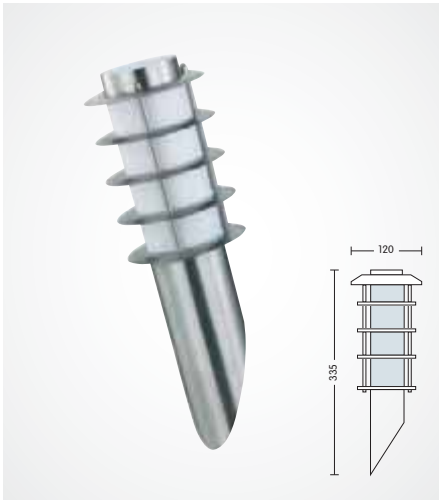

### HL 200

- 220-240V / 50-60Hz
- Stainless Steel and Galvanized Steel Body
- Diffuser: PC
- Max 60W
- Max 11W ESL



### HL 202

- 220-240V / 50-60Hz
- Stainless Steel and Galvanized Steel Body
- Diffuser: PC
- Max 60W
- Max 11W ESL

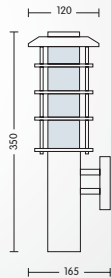
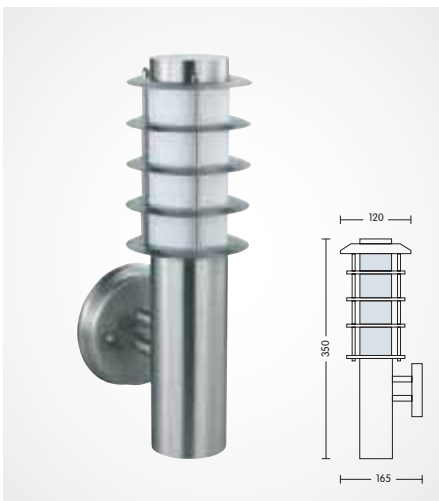

### HL 201

- 220-240V / 50-60Hz
- Stainless Steel and Galvanized Steel Body
- Diffuser: PC
- Max 60W
- Max 11W ESL

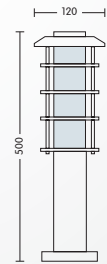
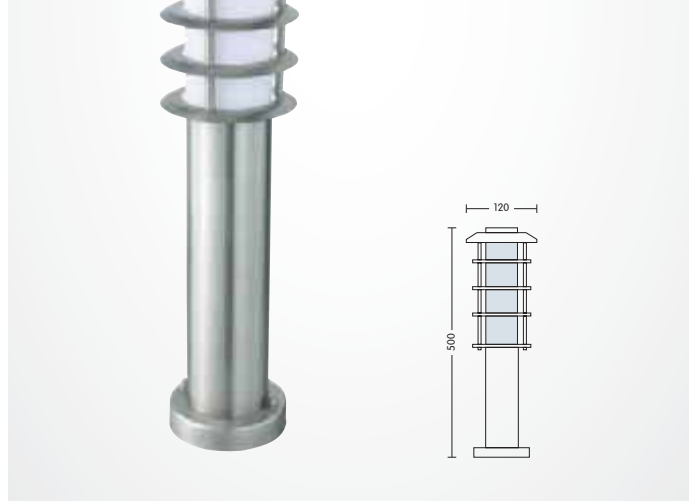

### HL 203

- 220-240V / 50-60Hz
- Stainless Steel and Galvanized Steel Body
- Diffuser: PC
- Max 60W
- Max 11W ESL

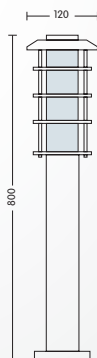

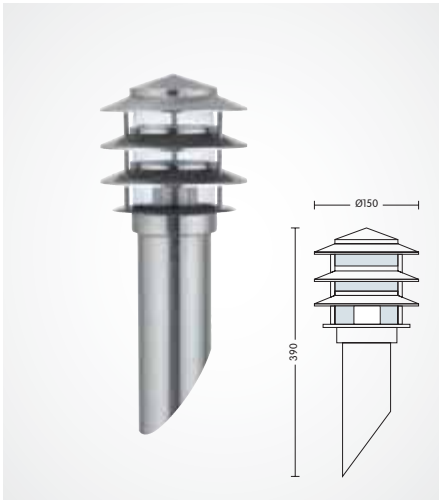

### HL 205

- 220-240V / 50-60Hz
- Stainless Steel and Galvanized Steel Body
- Diffuser: PC
- Max 60W

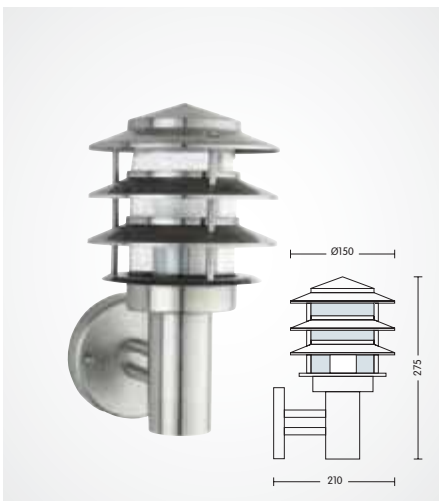

### HL 206

- 220-240V / 50-60Hz
- Stainless Steel and Galvanized Steel Body
- Diffuser: PC
- Max 60W



### HL 207

- 220-240V / 50-60Hz
- Stainless Steel and Galvanized Steel Body
- Diffuser: PC
- Max 60W



### HL 208

- 220-240V / 50-60Hz
- Stainless Steel and Galvanized Steel Body
- Diffuser: PC
- Max 60W



### HL 209

- 220-240V / 50-60Hz
- Stainless Steel and Galvanized Steel Body
- Diffuser: PC
- Max 60W





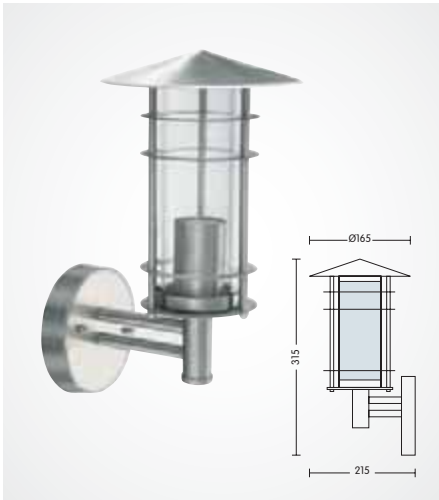

### HL 215

- 220-240V / 50-60Hz
- Stainless Steel and Galvanized Steel Body
- Diffuser: Glass
- Max 60W
- Max 11W ESL

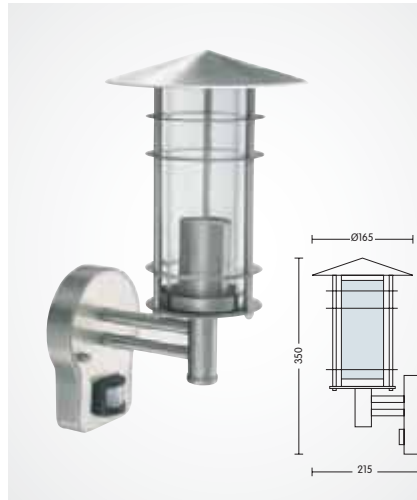

### HL 216

- 220-240V / 50-60Hz
- Stainless Steel and Galvanized Steel Body
- Diffuser: Glass
- Max 60W



### HL 220L

- 220-240V / 50-60Hz
- Stainless Steel Body
- Diffuser: PC
- Included Bulb
- Per Granule Max 0.12W

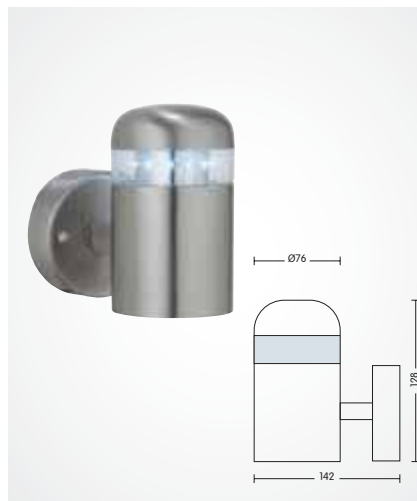

### HL 221L

- 220-240V / 50-60Hz
- Stainless Steel Body
- Diffuser: PC
- Included Bulb
- Per Granule Max 0.12W



### HL 223L

- 220-240V / 50-60Hz
- Stainless Steel Body
- Diffuser: PC
- Included Bulb
- Per Granule Max 0.12W



### HL 222L

- 220-240V / 50-60Hz
- Stainless Steel Body
- Diffuser: PC
- Included Bulb
- Per Granule Max 0.12W

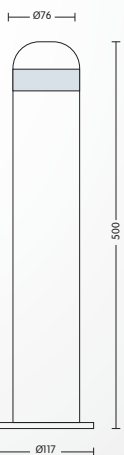



### HL 225L



- 220-240V / 50-60Hz
- Stainless Steel Body
- Diffuser: Clear PC
- Included Bulb
- Per Granule Max 0.12W





### HL 226L



- 220-240V / 50-60Hz
- Stainless Steel Body
- Diffuser: Clear PC
- Included Bulb
- Per Granule Max 0.12W





### HL 227L



- 220-240V / 50-60Hz
- Stainless Steel Body
- Diffuser: Clear PC
- Included Bulb
- Per Granule Max 0.12W





### HL 228L



- 220-240V / 50-60Hz
- Stainless Steel Body
- Diffuser: Clear PC
- Included Bulb
- Per Granule Max 0.12W







### HL 230

- 220-240V / 50-60Hz
- Stainless Steel Body
- Diffuser: PC
- Max 60W

E27, Ground, F, IP 44

### HL 231

- 220-240V / 50-60Hz
- Stainless Steel Body
- Diffuser: PC
- Max 60W

E27, SENSOR, Ground, F, IP 44

### HL 232

- 220-240V / 50-60Hz
- Stainless Steel Body
- Diffuser: PC
- Max 60W

E27, Ground, F, IP 44

### HL 233

- 220-240V / 50-60Hz
- Stainless Steel Body
- Diffuser: PC
- Max 60W

E27, Ground, F, IP 44

### HL 234

- 220-240V / 50-60Hz
- Stainless Steel Body
- Diffuser: PC
- Max 60W

E27, Ground, F, IP 44

### HL 235

- 220-240V / 50-60Hz
- Stainless Steel Body
- Diffuser: PC
- Max 60W

E27, Ground, F, IP 44

### HL 236

- 220-240V / 50-60Hz
- Stainless Steel Body
- Diffuser: PC
- Max 60W

E27, SENSOR, Ground, F, IP 44

### HL 237

- 220-240V / 50-60Hz
- Stainless Steel Body
- Diffuser: PC
- Max 60W

E27, Ground, F, IP 44

### HL 240

- 220-240V / 50-60Hz
- Stainless Steel Body
- Diffuser: Glass
- Max 60W

E27, Grounding, F, IP44

### HL 241

- 220-240V / 50-60Hz
- Stainless Steel Body
- Diffuser: Glass
- Max 60W

E27, SENSOR, Grounding, F, IP44

### HL 243

- 220-240V / 50-60Hz
- Stainless Steel Body
- Diffuser: Glass
- Max 60W

E27, Grounding, F, IP44

### HL 242

- 220-240V / 50-60Hz
- Stainless Steel Body
- Diffuser: Glass
- Max 60W

E27, Grounding, F, IP44

### HL 244

- 220-240V / 50-60Hz
- Stainless Steel Body
- Diffuser: Glass
- Max 60W

E27, Grounding, F, IP44

### HL 245

- 220-240V / 50-60Hz
- Stainless Steel Body
- Diffuser: Glass
- Max 60W

E27, Grounding, F, IP44

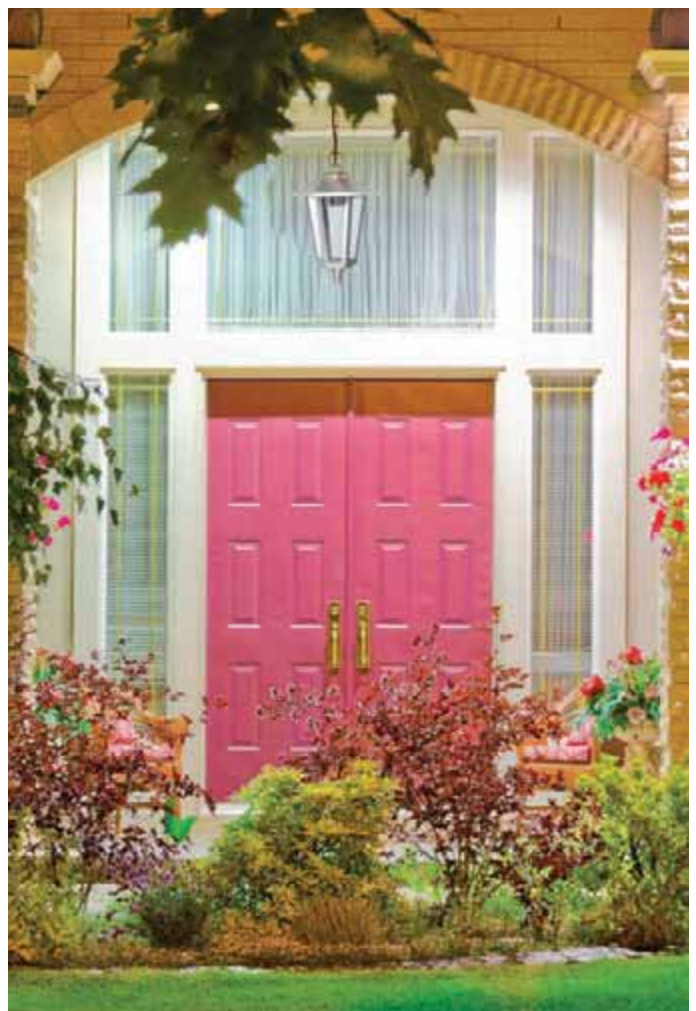



### HL 245P



- 220-240V / 50-60Hz
- Stainless Steel Body
- Diffuser: Glass
- Max 3x60W

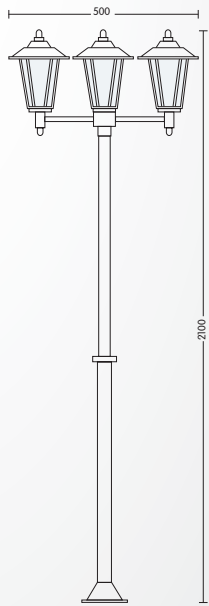

### HL 258P



- 220-240V / 50-60Hz
- Stainless Steel Body
- Diffuser: Glass
- Max 3x60W
- Max 3x11W ESL

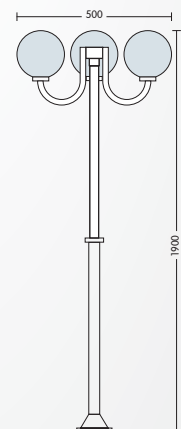



### HL 255

- 220-240V / 50-60Hz
- Stainless Steel Body
- Diffuser: Glass
- Max 60W
- Max 11W ESL

E27 E27

IP 33

### HL 256

- 220-240V / 50-60Hz
- Stainless Steel Body
- Diffuser: Glass
- Max 60W

E27 SENSOR

IP 33



### HL 257

- 220-240V / 50-60Hz
- Stainless Steel Body
- Diffuser: Glass
- Max 60W
- Max 11W ESL

E27 E27

IP 33

### HL 258

- 220-240V / 50-60Hz
- Stainless Steel Body
- Diffuser: Glass
- Max 60W
- Max 11W ESL

E27 E27

IP 33

### HL 260

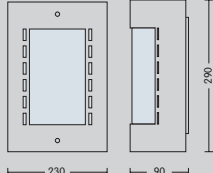
- 220-240V / 50-60Hz
- Stainless Steel Body
- Diffuser: PC
- Max 60W

E27 F IP44

### HL 261

- 220-240V / 50-60Hz
- Stainless Steel Body
- Diffuser: PC
- Max 60W

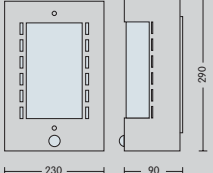
E27 SENSOR F IP44

### HL 262



- 220-240V / 50-60Hz
- Stainless Steel Body
- Diffuser: PC
- Max 60W

E27 F IP44

### HL 263



- 220-240V / 50-60Hz
- Stainless Steel Body
- Diffuser: PC
- Max 60W

E27 SENSOR F IP44

### HL 265



- 220-240V / 50-60Hz
- Stainless Steel Body
- Diffuser: Glass
- Max 35W

GU10 F IP44

### HL 266



- 220-240V / 50-60Hz
- Stainless Steel Body
- Diffuser: Glass
- Max 2x35W

GU10 F IP44

### HL 267



- 220-240V / 50-60Hz
- Aluminium Body
- Diffuser: Glass
- Max 2x11W ESL

E27 F IP44

### HL 217



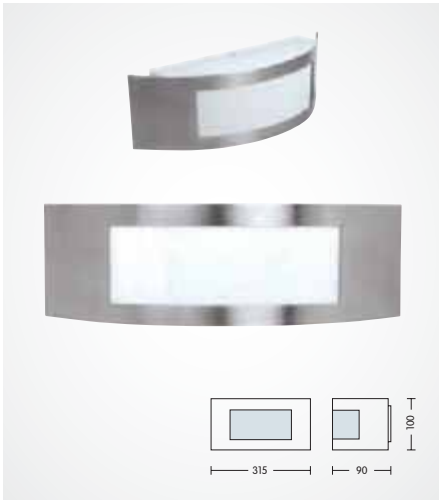

- 220-240V / 50-60Hz
- Stainless Steel Body
- Diffuser: PC & Glass
- Max 60W
- Max 11W ESL

E27 E27 F IP44

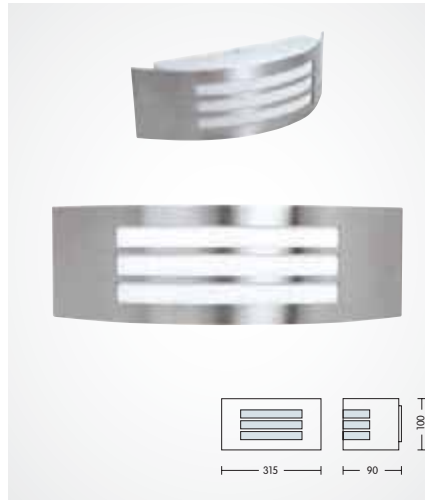

### HL 237

- 220-240V / 50-60Hz
- Stainless Steel Body+PC
- Max 15W ESL



### HL 238

- 220-240V / 50-60Hz
- Stainless Steel Body+PC
- Max 15W ESL

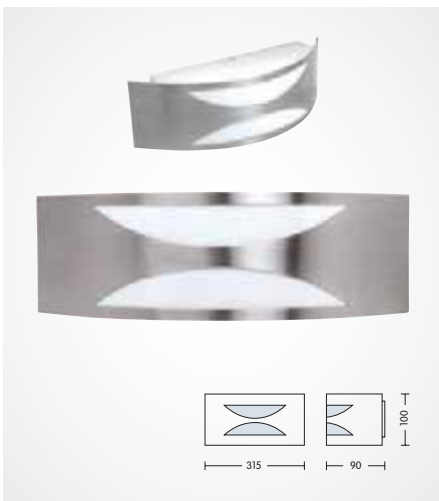

### HL 239

- 220-240V / 50-60Hz
- Stainless Steel Body+PC
- Max 15W ESL



### HL 246

- 220-240V / 50-60Hz
- Stainless Steel Body+PC
- Max 35W



### HL 247

- 220-240V / 50-60Hz
- Stainless Steel Body+PC
- Max 2x35W



### HL 248

- 220-240V / 50-60Hz
- Stainless Steel Body+PC
- Max 35W



### HL 249

- 220-240V / 50-60Hz
- Stainless Steel Body+PC
- Max 2x35W







### HL 218

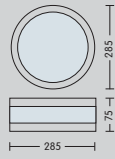

- 220-240V / 50-60Hz
- Stainless Steel Body+PC
- Max 2x11W ESL



### HL 219

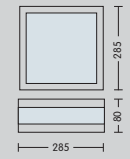

- 220-240V / 50-60Hz
- Stainless Steel Body+PC
- Max 2x11W ESL



### HL 270

ANTIQUE RED COPPER  
BLACK  
WHITE

- 220-240V / 50-60Hz
- Aluminium Body
- Diffuser: Glass
- Max 60W



### HL 271

ANTIQUE RED COPPER  
BLACK  
WHITE

- 220-240V / 50-60Hz
- Aluminium Body
- Diffuser: Glass
- Max 60W



### HL 272

ANTIQUE RED COPPER  
BLACK  
WHITE

- 220-240V / 50-60Hz
- Aluminium Body
- Diffuser: Glass
- Max 60W

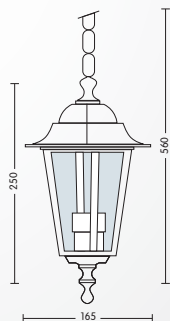



### HL 275

ANTIQUE RED COPPER  
BLACK  
WHITE



- 220-240V / 50-60Hz
- Aluminium Body
- Diffuser: Glass
- Max 60W

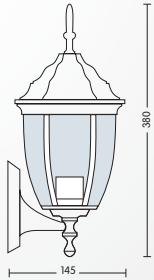

### HL 276

ANTIQUE RED COPPER  
BLACK  
WHITE



- 220-240V / 50-60Hz
- Aluminium Body
- Diffuser: Glass
- Max 60W

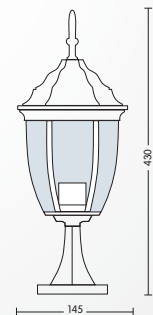

### HL 277

ANTIQUE RED COPPER  
BLACK  
WHITE



- 220-240V / 50-60Hz
- Aluminium Body
- Diffuser: Glass
- Max 60W

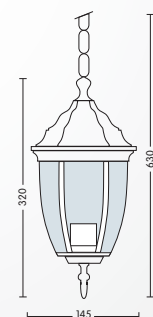



### HL 270P

BLACK

- 220-240V / 50-60Hz
- Aluminium Body
- Diffuser: Glass
- Max 3x60W

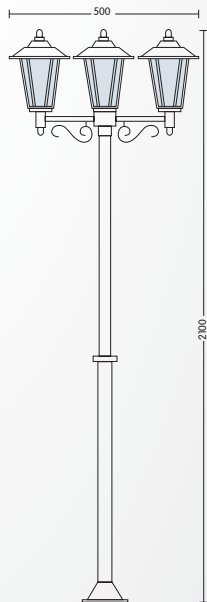

### HL 270M

BLACK

- 220-240V / 50-60Hz
- Aluminium Body
- Diffuser: Glass
- Max 60W

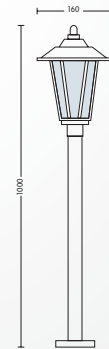

### HL 273P

BLACK

- 220-240V / 50-60Hz
- Aluminium Body
- Diffuser: Glass
- Max 60W



### HL 280



- 220-240V / 50-60Hz
- Aluminium Body
- Diffuser: Glass
- Max 50W

MR16  
53  
F  
IP 55

### HL 281



- 220-240V / 50-60Hz
- Aluminium Body
- Diffuser: Glass
- Max 50W

MR16  
53  
F  
IP 55

### HL 282



- 220-240V / 50-60Hz
- Aluminium Body
- Diffuser: Glass
- Max 50W

MR16  
53  
F  
IP 55



### HL 285L



- 220-240V / 50-60Hz
- Stainless Steel
- 2W

LED  
20 pcs  
F  
IP 68





Ø120 90  
Ø95

### HL 286L

- 220-240V / 50-60Hz
- Stainless Steel
- 3.2W

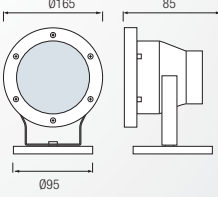
LED  
32 pcs  
F  
IP 68

Ø165 85  
Ø95



**Solar Lamps**



**HL 290L**

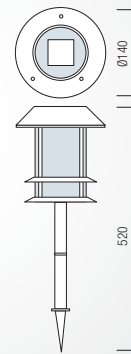

- Ni-MH AA600mAh 1.2V
- 1200-15000 cdm
- 0.24W



**HL 291L**

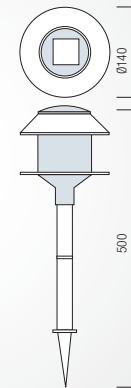

- Ni-MH AA600mAh 1.2V
- 1200-15000 cdm
- 0.12W



**HL 292L**

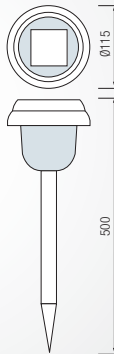

- Ni-MH AA600mAh 1.2V
- 1200-15000 cdm
- 0.12W



**HL 293L**

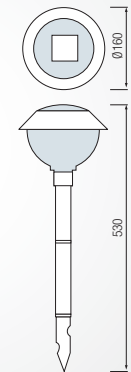

- Ni-MH AA600mAh 1.2V
- 1200-15000 cdm
- 0.12W



**HL 294L**

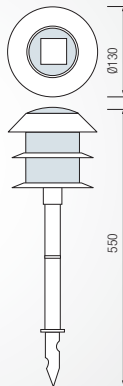

- Ni-MH AA600mAh 1.2V
- 1200-15000 cdm
- 0.12W





**HL 940L**

WHITE  
BLUE

• 220-240V / 50-60Hz  
• 1.2W

LED 12 pcs

IP 67

**HL 941L**

WHITE  
BLUE

• 220-240V / 50-60Hz  
• 1.2W

LED 12 pcs

IP 67

**Inground & Recessed Type LED Lamps**

CE RoHS

**HL 945L**



WHITE  
BLUE

• 220-240V / 50-60Hz  
• 1.8W

LED 18 pcs

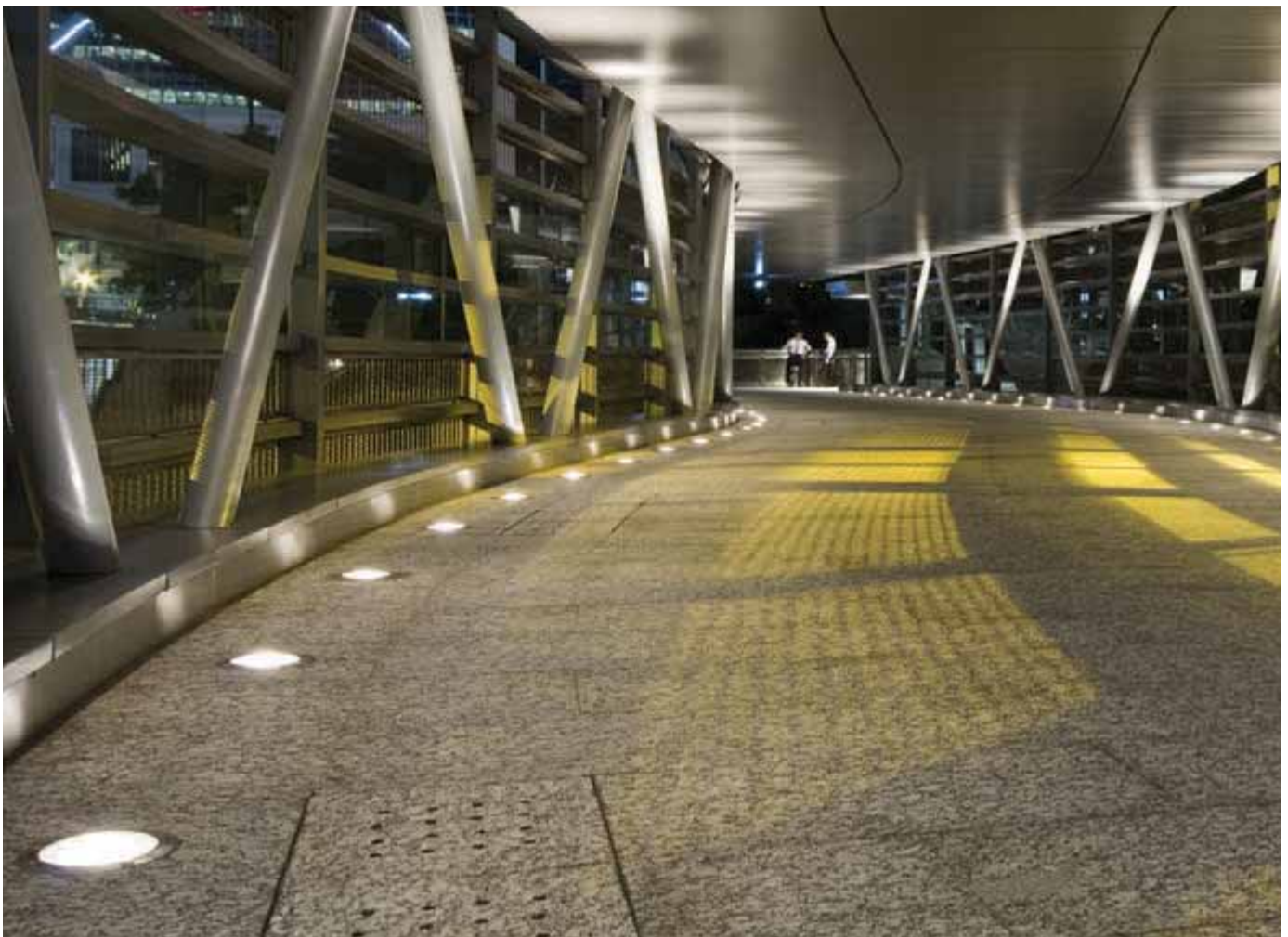
IP 67





**HL 931L**

WHITE  
BLUE

- 220-240V / 50-60Hz
- 1.5W

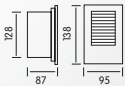

**HL 934L**

WHITE  
BLUE

- 220-240V / 50-60Hz
- 1.5W





**HL 932L**

WHITE  
BLUE

- 220-240V / 50-60Hz
- 1.8W





**HL 935L**

WHITE  
BLUE

- 220-240V / 50-60Hz
- 1.8W





**HL 933L**

WHITE  
BLUE

- 220-240V / 50-60Hz
- 2.7W





**HL 936L**

WHITE  
BLUE

- 220-240V / 50-60Hz
- 2.7W





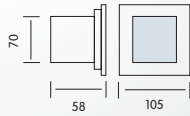

### HL 942L

WHITE  
BLUE

- 220-240V / 50-60Hz
- Aluminium + Stainless Steel, PCB Board
- 1.6W

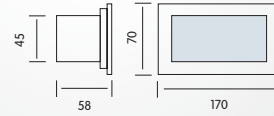

### HL 946L

WHITE  
BLUE

- 220-240V / 50-60Hz
- Aluminium + Stainless Steel, PCB Board
- 1.6W

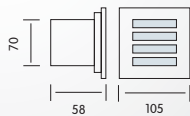

### HL 943L

WHITE  
BLUE

- 220-240V / 50-60Hz
- Aluminium + Stainless Steel, PCB Board
- 1.6W

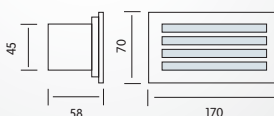

### HL 947L

WHITE  
BLUE

- 220-240V / 50-60Hz
- Aluminium + Stainless Steel, PCB Board
- 1.6W

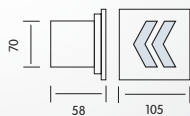

### HL 944L

WHITE  
BLUE

- 220-240V / 50-60Hz
- Aluminium + Stainless Steel, PCB Board
- 1.6W

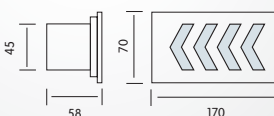

### HL 948L

WHITE  
BLUE

- 220-240V / 50-60Hz
- Aluminium + Stainless Steel, PCB Board
- 1.6W





**HL 951L**

WHITE  
BLUE



● 220-240V / 50-60Hz  
● Aluminium + Stainless Steel, PCB Board  
● 0.9W

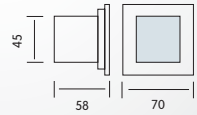

LED  
9 pcs

TT

F

IP 54

**HL 954L**

WHITE  
BLUE



● 220-240V / 50-60Hz  
● Aluminium + Stainless Steel, PCB Board  
● 1.2W

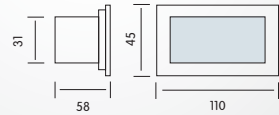

LED  
12 pcs

TT

F

IP 54

**HL 952L**

WHITE  
BLUE



● 220-240V / 50-60Hz  
● Aluminium + Stainless Steel, PCB Board  
● 0.9W



LED  
9 pcs

TT

F

IP 54

**HL 955L**

WHITE  
BLUE



● 220-240V / 50-60Hz  
● Aluminium + Stainless Steel, PCB Board  
● 1.2W

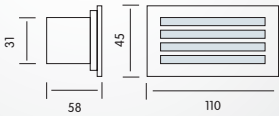

LED  
12 pcs

TT

F

IP 54

**HL 953L**

WHITE  
BLUE



● 220-240V / 50-60Hz  
● Aluminium + Stainless Steel, PCB Board  
● 0.9W

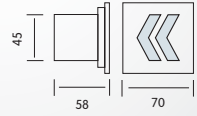

LED  
9 pcs

TT

F

IP 54

**HL 956L**

WHITE  
BLUE



● 220-240V / 50-60Hz  
● Aluminium + Stainless Steel, PCB Board  
● 1.2W



LED  
12 pcs

TT

F

IP 54







**LED Strips**  
**LED Drivers**  
**Waterproof LED Drivers**  
**RGB Controllers**  
**Ropelights**  
**Ropelight Controller**



COOL WHITE



WHITE 6400K



BLUE



GREEN



RED



YELLOW



RGB

Standart Length:  
1 m / 54 LED



3 LEDs make a group and each group can be cut or extended in terms of the length of application



**HL 540L**

WATERPROOF

- Operation Voltage: 12V DC
- Input Current: 2A (1 Roll/5m)
- Power: 24W (1 Roll/5m)
- Standart Length: 1 m / 60 LED
- LED Type: 35x28 SMD
- LED View Angle: 120
- Package: 5 m / Roll
- PCB Color: White
- With 3M Self-adhesive backing for easy installation

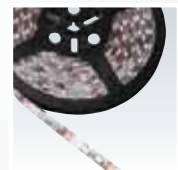

## HL 541L

NONWATERPROOF

- Operation Voltage: 12V DC
- Input Current: 2A (1 Roll/5m)
- Power: 24W (1 Roll/5m)
- Standart Length: 1 m / 60 LED
- LED Type: 35x28 SMD
- LED View Angle: 120
- Package: 5 m / Roll
- PCB Color: White
- With 3M Self-adhesive backing for easy installation



COOL WHITE



WHITE 6400K



BLUE

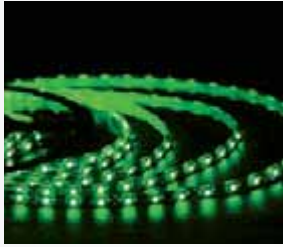

GREEN



RED



YELLOW



3 LEDs make a group and each group can be cut or extended in terms of the length of application



## HL 542L

WATERPROOF

- Operation Voltage: 12V DC
- Input Current: 6A (1 Roll/5m)
- Power: 72W (1 Roll/5m)
- Standart Length: 1 m / 60 LED
- LED Type: 50x50 SMD
- LED View Angle: 120
- Package: 5 m / Roll
- PCB Color: White
- With 3M Self-adhesive backing for easy installation



RGB



WHITE 6400K



BLUE



GREEN



RED



YELLOW



3 LEDs make a group and each group can be cut or extended in terms of the length of application

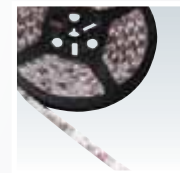



**HL 543L**

WATERPROOF

- Operation Voltage: 220-240V / 50-60Hz
- Power: 10W/m
- Standart Length: 1 m / 60 LED
- LED Type: 50x50 SMD
- LED View Angle: 120
- Package: 50 m / Roll
- 10 accessory



**220-240V**



WHITE 6400K



BLUE



GREEN



RED





**HL 544**

- AC 220-240V / 50-60Hz
- Output Voltage: DC 12V
- Output Power: 10W
- Output Current: 0,8A
- For 2m 35x28 SMD LED Strip
- For 1m 50x50 SMD LED Strip



**HL 545**

- AC 220-240V / 50-60Hz
- Output Voltage: DC 12V
- Output Power: 36W
- Output Current: 3A
- For 5m 35x28 SMD LED Strip
- For 1.5m 50x50 SMD LED Strip



**HL 546**

- AC 220-240V / 50-60Hz
- Output Voltage: DC 12V
- Output Power: 60W
- Output Current: 5A
- For 10m 35x28 SMD LED Strip
- For 4m 50x50 SMD LED Strip



**HL 547**

- AC 220-240V / 50-60Hz
- Output Voltage: DC 12V
- Output Power: 100W
- Output Current: 10A
- For 20m 35x28 SMD LED Strip
- For 8m 50x50 SMD LED Strip



**HL 548**

- AC 220-240V / 50-60Hz
- Output Voltage: DC 12V
- Output Power: 150W
- Output Current: 12A
- For 30m 35x28 SMD LED Strip
- For 10m 50x50 SMD LED Strip



**HL 549**

- AC 220-240V / 50-60Hz
- Output Voltage: DC 12V
- Output Power: 200W
- Output Current: 17A
- For 40m 35x28 SMD LED Strip
- For 13m 50x50 SMD LED Strip

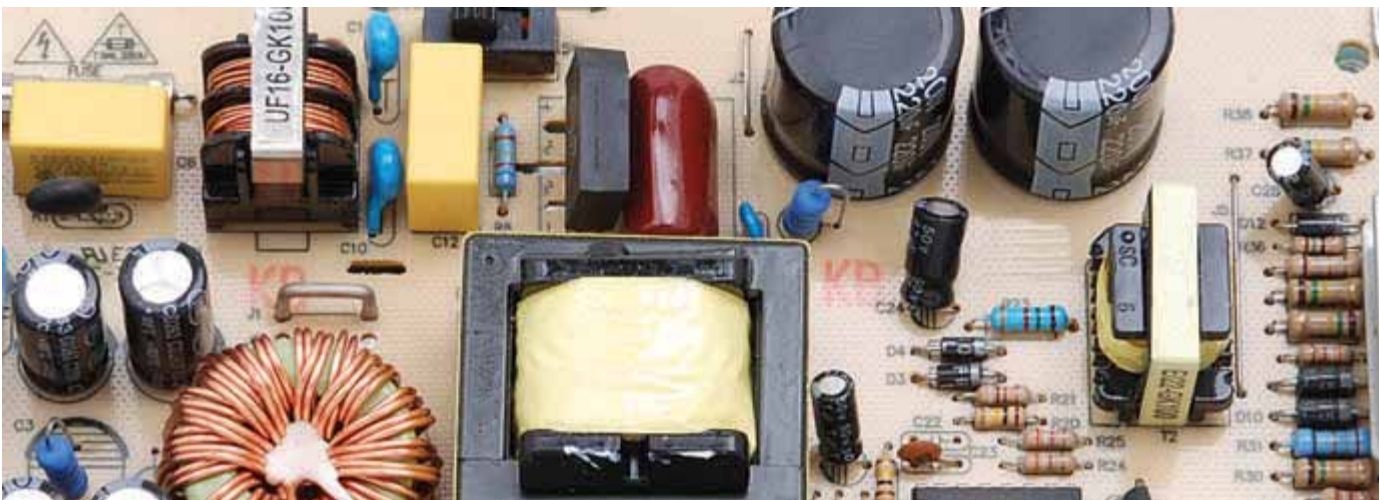





### HL 553

WATERPROOF

- AC 220-240V / 50-60Hz
- Output Voltage: DC 12V
- Output Power: 25W
- Output Current: 2A
- For Max. 5m 35x28 SMD Led Strip
- For Max. 1.7m 50x50 SMD Led Strip



### HL 555

WATERPROOF

- AC 220-240V / 50-60Hz
- Output Voltage: DC 12V
- Output Power: 60W
- Output Current: 5A
- For Max. 12m 35x28 SMD Led Strip
- For Max. 4m 50x50 SMD Led Strip



### HL 557

WATERPROOF

- AC 220-240V / 50-60Hz
- Output Voltage: DC 12V
- Output Power: 120W
- Output Current: 10A
- For Max. 25m 35x28 SMD Led Strip
- For Max. 8m 50x50 SMD Led Strip



### HL 558

WATERPROOF

- AC 220-240V / 50-60Hz
- Output Voltage: DC 12V
- Output Power: 180W
- Output Current: 15A
- For Max. 37m 35x28 SMD Led Strip
- For Max. 12m 50x50 SMD Led Strip



### HL 559

WATERPROOF

- AC 220-240V / 50-60Hz
- Output Voltage: DC 12V
- Output Power: 200W
- Output Current: 17A
- For Max. 40m 35x28 SMD Led Strip
- For Max. 13m 50x50 SMD Led Strip



### RGB Controller 4A

For Max. 30m 35x28 SMD LED Strip

For Max. 10m 50x50 SMD LED Strip

- DC 12V - 24V
- Output Voltage: DC 12V - 24V
- Output Power: 144W
- Output Current: 4A/Each Color



### RGB Controller 2A

For Max. 15m 35x28 SMD LED Strip

For Max. 5m 50x50 SMD LED Strip

- DC 12V - 24V
- Output Voltage: DC 12V - 24V
- Output Power: 72W
- Output Current: 2A/Each Color





CLEAR



YELLOW



RED



BLUE

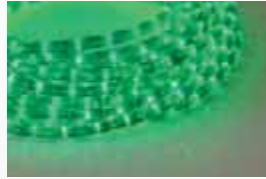

GREEN



COLORFULL

### ROPELIGHT

2 LINE  
100m ROLL  
13 mm  
10 accessories

● 220-240V / 50-60Hz



CLEAR



YELLOW



RED

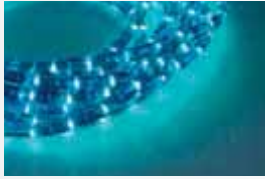

BLUE

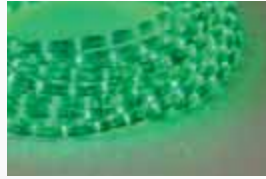

GREEN



COLORFULL

### LED ROPELIGHT

2 LINE  
100m ROLL  
13 mm  
10 accessories

● 220-240V / 50-60Hz



### ROPELIGHT CONTROLLER

3 LINE  
10 m

● 220-240V / 50-60Hz  
● 8 programs  
● Max. Power 200W



**HL 334L**

RECHARGEABLE LED TORCH



- 220-240V / 50-60Hz
- 1W
- 4V 900mAh Rechargeable Sealed-Acid Battery
- Duration Time: 2,5 Hours

POWERLED  
1 pcs

F IP 20

**HL 335L**

RECHARGEABLE LED TORCH



- 220-240V / 50-60Hz
- 1W
- 4V 900mAh Rechargeable Sealed-Acid Battery
- Duration Time: 2,5 Hours

POWERLED  
1 pcs

F IP 20



**Rechargeable & Emergency Lanterns**

PCB RoHS



**HL 336L**

RECHARGEABLE LED TORCH



- 220-240V / 50-60Hz
- 3W
- 4V 3Ah Rechargeable Sealed-Acid Battery
- Duration Time: 4 Hours

POWERLED  
1 pcs

F IP 20

**HL 337L**

RECHARGEABLE LED TORCH



- 220-240V / 50-60Hz
- 3W
- 6V 4,5Ah Rechargeable Sealed-Acid Battery
- Duration Time: 6 Hours

POWERLED  
1 pcs

F IP 20

**HL 338L**

RECHARGEABLE LED LANTERN



- 220-240V / 50-60Hz
- 19x1500 MCD 110° Bright Led Torch
- 1,9W
- 4V 3Ah Rechargeable Sealed-Acid Battery
- Duration Time: 7 Led 24 Hours, 19 Led 10 Hours

LED  
19 pcs

F IP 20

**HL 339L**

RECHARGEABLE LED LANTERN



- 220-240V / 50-60Hz
- 36x1500 MCD 110° Bright Led Torch
- 3,6W
- 6V 4,5Ah Rechargeable Sealed-Acid Battery
- Duration Time: 16 Led 15 Hours, 36 Led 6 Hours

LED  
36 pcs

F IP 20





### HL 331L

RECHARGEABLE LED TORCH

- 220-240V / 50-60Hz
- 4x1500 MCD 110° Bright Led Torch
- 4V 400mAh Rechargeable Sealed-Acid Battery
- Duration Time: 5 Hours



### HL 332L

RECHARGEABLE LED TORCH

- 220-240V / 50-60Hz
- 5x1500 MCD 110° Bright Led Torch
- 4V 400mAh Rechargeable Sealed-Acid Battery
- Duration Time: 4 Hours



### HL 333L

RECHARGEABLE LED TORCH

- 220-240V / 50-60Hz
- 9x1500 MCD 110° Bright Led Torch
- 4V 1.0Ah Rechargeable Sealed-Acid Battery
- Duration Time: 5Hours



### HL 340

- 12V
- 35W Bulb





**NEW** HL 3094L

RECHARGEABLE LED LANTERN

ORANGE  
GREEN  
PURPLE  
DARK RED  
BLUE

- 220-240V / 50-60Hz
- 4x0,1W
- 9.000-15.000K
- 30.000 Hours



HL 318L

RECHARGEABLE LED LANTERN

- 220-240V / 50-60Hz
- 9x1500 MCD 110°  
Bright Led Light
- 4V 0,6Ah Rechargeable Sealed-Acid Battery
- Duration Time:  
6 Led: 8 Hours  
3 Led: 16 Hours



**NEW** HL 3094L

RECHARGEABLE LED LANTERN

ORANGE  
GREEN  
PURPLE  
DARK RED  
BLUE

- 220-240V / 50-60Hz
- 4x0,1W
- 9.000-15.000K
- 30.000 Hours



HL 329L

RECHARGEABLE LED LANTERN

- 220-240V / 50-60Hz
- 10x1500 MCD 110°  
Bright Led Light
- 4V 2,0Ah Rechargeable Sealed-Acid Battery
- Duration Time: 10 Hours
- 360° Light Distribution
- Light Adjusting



**NEW** HL 3099L

RECHARGEABLE LED LANTERN

ORANGE  
GREEN  
PURPLE  
DARK RED  
BLUE

- 220-240V / 50-60Hz
- 4x0,1W
- 9.000-15.000K
- 30.000 Hours



HL 319L

RECHARGEABLE LED LANTERN

- 220-240V / 50-60Hz
- 18x1500 MCD 110°  
Bright Led Light
- 3x1500 MCD 110°  
Bright Led Torch
- 6V 4,0Ah Rechargeable Sealed-Acid Battery
- Duration Time:  
For 18 Led 35 Hours  
For 3 Led 50 Hours



HL 327L

RECHARGEABLE LED TORCH

- 220-240V / 50-60Hz
- 7x1500 MCD 110°  
Bright Led Torch
- 4V 1,0Ah Rechargeable Sealed-Acid Battery
- Duration Time: 8 Hours



HL 319LR

RECHARGEABLE LED LANTERN WITH RADIO

- 220-240V 50/60 Hz
- 24x1500 MCD 110°  
Bright Led Light
- 3x1500 MCD 110°  
Bright Led Torch
- 6V 2,0Ah Rechargeable Sealed-Acid Battery
- Duration time  
For 24 Led: 12 hours  
For 3 Led: 24 hours  
For Radio: 8 hours





### HL 300

RECHARGEABLE WALL-MOUNTED LANTERN

- 220-240V / 50-60Hz
- 1 x 20W
- 6V 4,0Ah Rechargeable Sealed-Acid Battery
- Duration Time: 3,5 Hours
- Ceiling & Wall-Mounted
- Emergency & Automatic Light-Up



### HL 303

RECHARGEABLE WALL-MOUNTED LANTERN

- 220-240V / 50-60Hz
- 2 x 8W
- 6V 2,8Ah Rechargeable Sealed-Acid Battery
- Duration Time: 1 Tube 5 Hours, 2 Tubes 2.5 Hours
- Ceiling & Wall-Mounted
- Emergency & Automatic Light-Up



### HL 323L

RECHARGEABLE LED LANTERN

- 220-240V / 50-60Hz
- 35x1500 MCD 110° Bright Led Light
- 6V 2,8Ah Rechargeable Sealed-Acid Battery
- Duration Time: 15 Hours
- Ceiling & Wall-Mounted
- Emergency & Automatic Light-Up



### HL 312L

RECHARGEABLE LED LANTERN

- 220-240V / 50-60Hz
- 60x1500 MCD 110° Bright Led Light
- 4x4V 1Ah Rechargeable Sealed-Acid Battery
- Duration Time: Step 1: 10 Hours, Step 2: 4 Hours



### HL 313L

RECHARGEABLE LED LANTERN

- 220-240V / 50-60Hz
- 32x1500 MCD 110° Bright Led Light
- 2x4V 1Ah Rechargeable Sealed-Acid Battery
- Duration Time: Step 1: 6 Hours, Step 2: 3 Hours



### HL 320L

RECHARGEABLE LED LANTERN

- 220-240V / 50-60Hz
- 36x1500 MCD 110° Bright Led Light
- 4x4V 1,0Ah Rechargeable Sealed-Acid Battery
- Duration Time: 1 Line 12 Hours, 2 Lines 6 Hours
- Ceiling & Wall-Mounted
- Emergency & Automatic Light-Up



### HL 321L

RECHARGEABLE LED LANTERN

- 220-240V / 50-60Hz
- 60x1500 MCD 110° Bright Led Light
- 6V 2,8Ah Rechargeable Sealed-Acid Battery
- Duration Time: 1 Line 22 Hours, 2 Lines 12 Hours, 3 Lines 8 Hours
- Ceiling & Wall-Mounted
- Emergency & Automatic Light-Up





### HL 322L

#### RECHARGEABLE LED LANTERN

- 220-240V / 50-60Hz
- 24x1500 MCD 110° Bright Led Light
- 6V 2.0Ah Rechargeable Sealed-Acid Battery
- Duration Time:
  - 1 Line 32 Hours
  - 2 Lines 20 Hours
  - 3 Lines 13 Hours
- Ceiling & Wall-Mounted
- Emergency & Automatic Light-Up



### HL 306

#### EMERGENCY EXIT & SAFETY EMERGENCY LANTERN

- 220-240V / 50-60Hz
- 1 x 6W
- 2x4V 1.0Ah Rechargeable Sealed-Acid Battery
- Duration Time: 90 Minutes
- Ceiling & Wall-Mounted
- Emergency & Automatic Light-Up



### HL 306L

#### EMERGENCY EXIT & SAFETY EMERGENCY LANTERN

- 220-240V / 50-60Hz
- 18x1500 MCD 110° Bright Led Light
- 2x4V 1.0Ah Rechargeable Sealed-Acid Battery
- Duration Time: 6 Hours
- Ceiling & Wall-Mounted
- Emergency & Automatic Light-Up



### HL 308

#### EMERGENCY EXIT & SAFETY EMERGENCY LANTERN

- 220-240V / 50-60Hz
- 1 x 8W
- 2x4V 1.0Ah Rechargeable Sealed-Acid Battery
- Duration Time: 90 Minutes
- Ceiling & Wall-Mounted
- Emergency & Automatic Light-Up



### HL 308L

#### EMERGENCY EXIT & SAFETY EMERGENCY LANTERN

- 220-240V / 50-60Hz
- 24x1500 MCD 110° Bright Led Light
- 2x4V 1.0Ah Rechargeable Sealed-Acid Battery
- Duration Time: 5 Hours
- Ceiling & Wall-Mounted
- Emergency & Automatic Light-Up





### HL 304L

RECHARGEABLE  
LED DESK LAMP

- 220-240V / 50-60Hz
- 25x1500 MCD 110°  
Bright Led Light
- 6V 2Ah Rechargeable  
Sealed-Acid Battery
- Duration time  
For 24 Led: 10 hours  
For 1 Led: 100 hours



### HL 304LR

RECHARGEABLE  
LED DESK LAMP  
WITH RADIO

- 220-240V / 50-60Hz
- 24x1500 MCD 110°  
Bright Led Light
- 2x4V 900mAh Rechargeable  
Sealed-Acid Battery
- Duration time  
For 24 Led: 4 hours  
Radio: 3 hours



### HL 310L

RECHARGEABLE  
LED LAMP  
E27

- 220-240V / 50-60Hz
- 10x1500 MCD 110°  
Bright Led Light
- 4V 1.0Ah Rechargeable  
Sealed-Acid Battery
- Duration Time: 6 Hours
- Emergency &  
Automatic Light-Up
- AC / DC Operated



### HL 315L

RECHARGEABLE  
LED LAMP

- 220-240V / 50-60Hz
- 12x1500 MCD 110°  
Bright Led Light
- 4V 0,4 Ah Rechargeable  
Sealed-Acid Battery
- Duration time  
Step 1: 4 hours  
Step 2: 2 hours



### HL 330L

EMERGENCY  
EXIT & SAFETY  
LED LAMP

- 220-240V / 50-60Hz
- 6x1500 MCD 110°  
Bright Led Light
- 3.6V 360mAh Rechargeable  
Ni-Cd Battery







**HL 991L**

WHITE  
BLUE  
GREEN  
RED

● 220-240V / 50-60Hz



**HL 992L**

WHITE  
BLUE  
GREEN  
RED

● 220-240V / 50-60Hz



**Night Lamps**



**HL 993L**

WHITE  
BLUE  
GREEN  
RED

● 220-240V / 50-60Hz



**HL 994L**

WHITE  
BLUE  
GREEN  
RED

● 220-240V / 50-60Hz



**HL 990L**

WHITE  
BLUE  
YELLOW  
GREEN  
RED

● 220-240V / 50-60Hz



**HL 980**

WHITE  
BLUE  
YELLOW  
GREEN  
RED

● 220-240V / 50-60Hz  
● 1W



**HL 981**

WHITE  
(LANDSCAPE)

● 220-240V / 50-60Hz  
● 1.5W





**HL 982**

WHITE  
BLUE  
YELLOW  
GREEN  
RED

● 220-240V / 50-60Hz  
● 3W



**HL 983**

WHITE  
BLUE  
YELLOW  
GREEN  
RED

● 220-240V / 50-60Hz  
● 1W



**HL 985**

WHITE  
BLUE  
YELLOW  
GREEN  
RED

● 220-240V / 50-60Hz  
● 1.5W



**HL 986**

BLUE  
YELLOW  
ORANGE  
GREEN  
BLACK

● 220-240V / 50-60Hz  
● 1W





**HL 490**



**Smoke Detector**

- Alkaline 9 V
- Loud Alarm 85db
- Battery Supplied
- Alarms for 10 Minutes

**HL 452**



**Specification**

- Power Source: Emitter - 12V DC (Battery Included)
- Receiving: 3V/DC (2xAA1.5V)
- Working frequency: 315MHz
- Distance: 150m (open position )
- Sound level: 60 db max
- Sound type: 38 songs optional



**Detector  
Doorbells  
Sensors  
Light Control Photosensors**



**HL 453**



**Specification**

- Power Source: Emitter - 12V DC (Battery Included)
- Receiving: 4.5V/DC (3xAA1.5V)
- Working frequency: 315MHz
- Distance: 150m (open position )
- Sound level: 60 db max
- Sound type: 38 songs optional



**HL 454**



**Specification**

- Operation Voltage: 4.5V DC (3xAA1.5V) or 12V DC Adaptor
- Sensing Distance: 6 m
- Distance Range: 110°
- Sound level: 60 db max
- Sound type: Ding Dong, Hello, Welcome + Alarm



**NEW**

**HL 455**



**Specification**

- 4.5V
- Work Voltage of the Emitter: 12V
- Work Frequency: 315 Mhz
- Remote Control: 120m (in open air)
- Sound Type: 38 Songs Optional



**NEW**

**HL 456**



**Specification**

- 4.5V
- Work Voltage of the Emitter: 12V
- Work Frequency: 315 Mhz
- Remote Control: 120m (in open air)
- Sound Type: 38 Songs Optional



**NEW**

**HL 457**



**Specification**

- 4.5V
- Work Voltage of the Emitter: 12V
- Work Frequency: 315 Mhz
- Remote Control: 120m (in open air)
- Sound Type: 38 Songs Optional





### HL 480

WHITE  
BLACK

#### Specification

- Operation Voltage: 220-240V / 50-60Hz
- Detection Distance: 8 ± 1 m Max. (<24°C)
- Time-delay: 5 sec ~ 10±2 min.
- Ambient Light: < 10Lux ~ 2000Lux
- Average Load: Max 1000W



### HL 481

WHITE  
BLACK

#### Specification

- Operation Voltage: 220-240V / 50-60Hz
- Detection Distance: 8 ± 1 m Max. (<24°C)
- Time-delay: 5 sec ~ 10±2 min.
- Ambient Light: < 10Lux ~ 2000Lux
- Average Load: Max 1000W (~220V AC)



### HL 482

WHITE  
BLACK

#### Specification

- Operation Voltage: 220-240V / 50-60Hz
- Detection Distance: 8 ± 2 m Max. (<24°C)
- Time-delay: 5 sec ~ 8±2 min.
- Ambient Light: < 10Lux ~ 2000Lux
- Average Load: Max 1000W (~220V AC)



### HL 483

WHITE  
BLACK

#### Specification

- Operation Voltage: 220-240V / 50-60Hz
- Detection Distance: >8m Max. (<22°C) (adjustable)
- Time-delay: Max: 5 sec ~10±2 min. (adjustable)
- Ambient Light: < 10Lux ~ 1000Lux
- Sound Control Sensitivity: 30db ~ 90db (adjustable)
- Average Load: 500W (220V/AC~240V/AC)



### HL 470

#### Specification

- Operation Voltage: 220-240V / 50-60Hz
- Ambient Light: <50Lux
- Load Power: 1000W (6A)

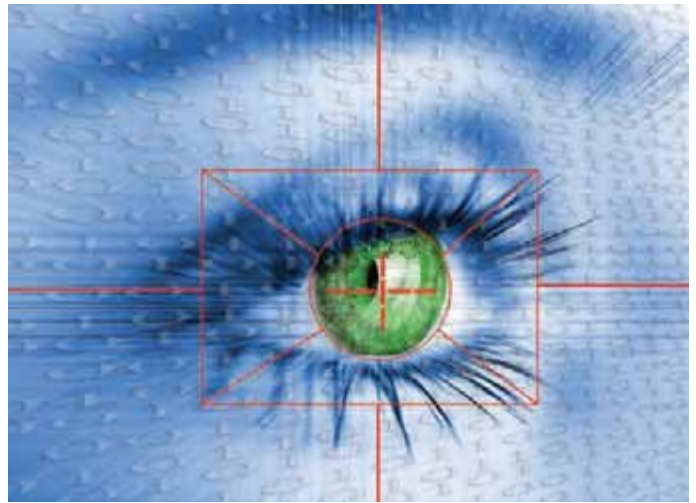

### HL 471

#### Specification

- Operation Voltage: 220-240V / 50-60Hz
- Ambient Light: <50Lux
- Load Power: 1200W (10A)



### HL 472

#### Specification

- Operation Voltage: 220-240V / 50-60Hz
- Ambient Light: <50Lux
- Load Power: 2700W (25A)







**HL 380** 10W  
**HL 381** 15W  
**HL 382** 18W  
**HL 383** 30W  
**HL 384** 36W

ELECTRONIC BALLAST

● 220-240V / 50-60Hz



**HL 385** 2x18W  
**HL 386** 2x36W

ELECTRONIC BALLAST

● 220-240V / 50-60Hz



**Ballast & Transformers**



**HL 387** 4x18W  
**HL 388** 4x36W

ELECTRONIC BALLAST

● 220-240V / 50-60Hz



**HL 350** 10W  
**HL 351** 13W  
**HL 352** 18W  
**HL 353** 26W

MAGNETIC BALLAST

FOR PL OR PLC LAMP

● 220-240V / 50-60Hz



**HL 355** 18W  
**HL 356** 36W

MAGNETIC BALLAST

FOR FLOURESCENT LAMP

● 220-240V / 50-60Hz



**HL 389** 125W  
**HL 390** 250W  
**HL 391** 400W

MAGNETIC BALLAST

FOR MERCURY LAMP

● 220-240V / 50-60Hz



**HL 392** 70W  
**HL 393** 150W  
**HL 394** 250W  
**HL 395** 400W

MAGNETIC BALLAST

FOR METAL HALIDE LAMP

● 220-240V / 50-60Hz





**HL 360 12V, 50W**

MAGNETIC TRANSFORMER

● 220-240V / 50-60Hz

⊕ F IP20



**HL 361 12V, 105W**

MAGNETIC TRANSFORMER

● 220-240V / 50-60Hz

⊕ F IP20



**HL 370 12V, 60W**  
**HL 371 12V, 105W**  
**HL 372 12V, 150W**

ELECTRONIC TRANSFORMER

● 220-240V / 50-60Hz

⊕ F IP20



**HL 373**

ELECTRONIC TRANSFORMER

● Dimmable  
 ● Short Circuit Protection  
 ● Over-Load Protection  
 ● EMC Approved  
 ● Pri: AC220-240V/50-60Hz, 0.23A  
 ● Sec: AC11.6v, 4.3A  
 ● Rated Load: 50W  
 ● TA: MAX. 45°C TC: MAX. 70°C

CE M M F 100 IP20



**HL 374**

ELECTRONIC TRANSFORMER

● Dimmable  
 ● Short Circuit Protection  
 ● Over-Load Protection  
 ● EMC Approved  
 ● Pri: AC220-240V/50-60Hz, 0.46A  
 ● Sec: AC11.6v, 8.8A  
 ● Rated Load: 100W  
 ● TA: MAX. 45°C TC: MAX. 70°C

CE M M F 100 IP20



**HL 375**

ELECTRONIC TRANSFORMER

● Dimmable  
 ● Short Circuit Protection  
 ● Over-Load Protection  
 ● EMC Approved  
 ● Pri: AC220-240V/50-60Hz, 0.60A  
 ● Sec: AC11.6v, 12A  
 ● Rated Load: 150W  
 ● TA: MAX. 45°C TC: MAX. 75°C

CE M M F 100 IP20



**HL 376**

ELECTRONIC TRANSFORMER

● Dimmable  
 ● Short Circuit Protection  
 ● Over-Load Protection  
 ● EMC Approved  
 ● Pri: AC220-240V/50-60Hz, 0.80A  
 ● Sec: AC11.6v, 16A  
 ● Rated Load: 200W  
 ● TA: MAX. 45°C TC: MAX. 75°C

CE M M F 100 IP20



**HL 377**

ELECTRONIC TRANSFORMER

● Dimmable  
 ● Short Circuit Protection  
 ● Over-Load Protection  
 ● EMC Approved  
 ● Pri: AC220-240V/50-60Hz, 1.0A  
 ● Sec: AC11.6v, 21A  
 ● Rated Load: 250W  
 ● TA: MAX. 45°C TC: MAX. 75°C

CE M M F 100 IP20

### HL 396 70W

METAL HALIDE  
BALLAST KITS



- 220-240V / 50-60Hz
- Built-in suitable ignitor, ballast, capacitor.



### HL 397 150W

METAL HALIDE  
BALLAST KITS



- 220-240V / 50-60Hz
- Built-in suitable ignitor, ballast, capacitor.

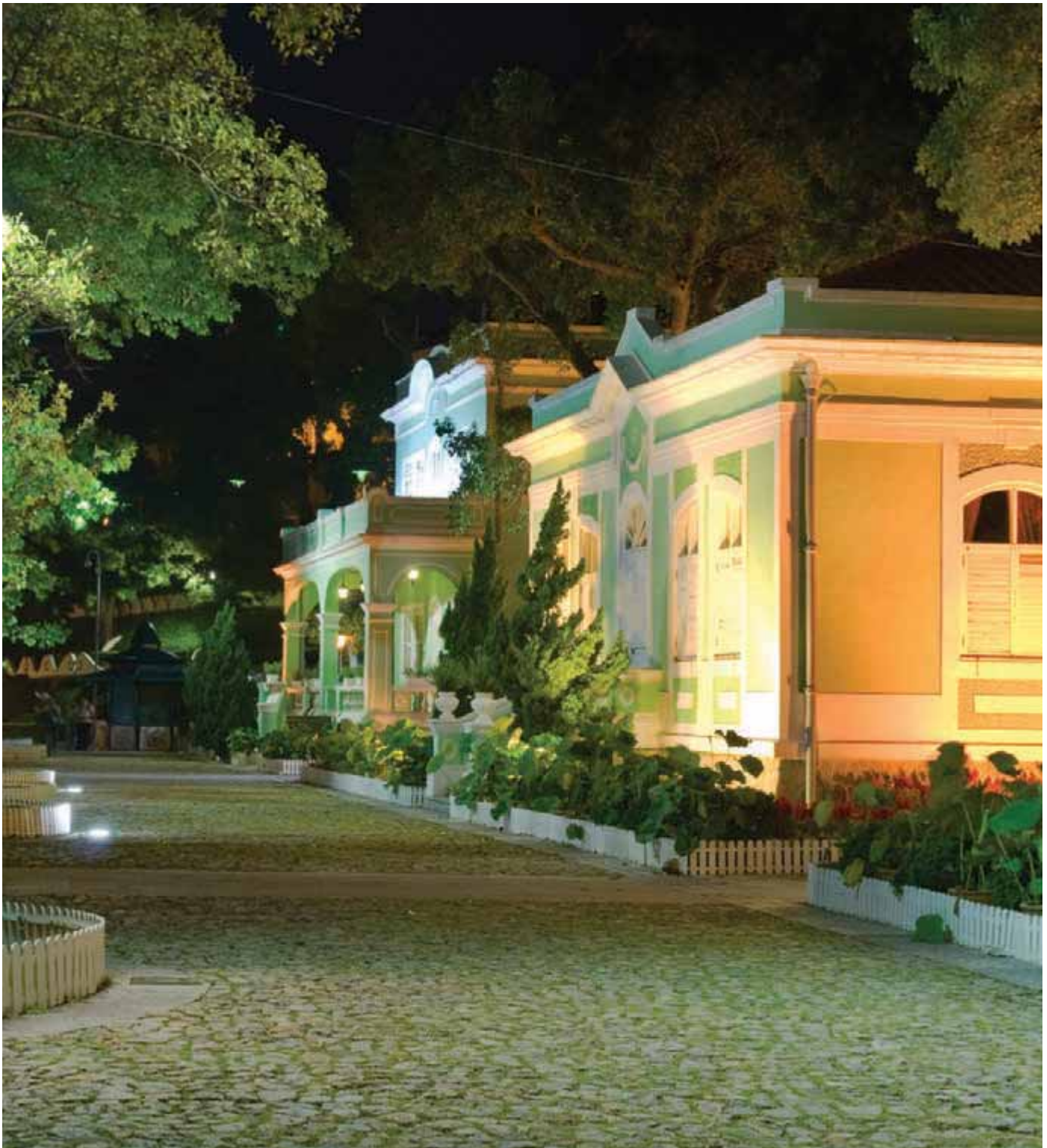



HL 580



HL 581



Lamp Holders



HL 582



HL 583



HL 584



HL 585





**HL 586**



**HL 587**



**HL 550**

10cm  
15cm  
20cm



**HL 551**

15cm



**HL 590**



**HL 591**



**HL 592**



**HL 593**





### Starter S2

220-240V  
SINGLE  
4-6-8-15-18-22W

110-130V SINGLE  
220-240V SERIES  
4-22W



### Starter S10

220-240V  
SINGLE  
4-65W



**Starters, Switch With Rope  
Socket, Connector, UTP Cat5e  
Cable Ties, Nail Cable Clips  
RG6, Adhesive Tapes  
Terminal Blocks**



### SWITCH WITH ROPE

HL 950



### CONNECTOR

(MODEL: HL 2001)



6,8 PVC	64x0,12 AL. BRAIDING	AL. FOIL BONDED	4,8 FPE	1,02 CCS
---------	-------------------------	--------------------	---------	----------



### RG6

COAXIAL CABLE  
100m ROLL



**SOCKET**

WATERPROF LED STRIP  
(FOR HL 543L)

INPUT VOLTAGE  
220V AC

CABLE FEATURE  
2x0,75mm<sup>2</sup> Flexible



**UTP Cat5e**

NETWORK CABLE  
305m ROLL



**NAIL CABLE CLIPS**

CIRCLE	NAIL
4 mm	1.7 x 15
5 mm	1.7 x 15
6 mm	1.7 x 17
7 mm	1.8 x 19
8 mm	1.9 x 21
9 mm	2.0 x 22
10 mm	2.05 x 25
12 mm	2.05 x 27
14 mm	2.4 x 32
16 mm	2.5 x 35
18 mm	2.5 x 37
22 mm	2.8 x 48



**CABLE TIES**

2,5*100	4,8*400
2,5*150	7,2*300
2,5*200	7,2*350
3,6*150	7,2*400
3,6*200	7,2*450
3,6*250	7,9*350
3,6*280	7,9*400
3,6*300	7,9*450
3,6*370	7,9*500
4,8*200	9*550
4,8*250	9*650
4,8*300	9*750
4,8*350	9*1020
4,8*370	



**TERMINAL BLOCKS**

3 A,	4 mm <sup>2</sup>
5 A,	6 mm <sup>2</sup>
10 A,	10 mm <sup>2</sup>
30 A,	16 mm <sup>2</sup>
60 A,	25 mm <sup>2</sup>



**ADHESIVE TAPES**

10 YARD  
20 YARD

WHITE  
YELLOW  
RED  
BLUE  
GREEN  
BLACK





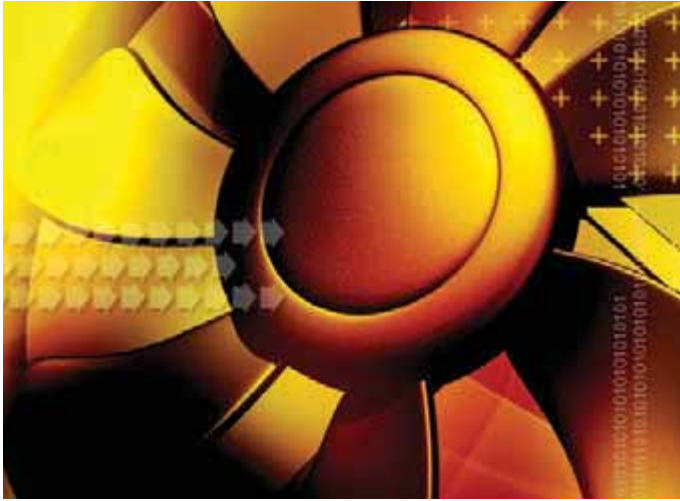

## Exhaust Fans Plastic Fans



### HL 960

- 220-240V / 50-60Hz
- Air Flow: 450
- Speed: 1200
- Power Input: 35W
- Weight: 1,8kg
- Product Size: 24.8cm x 24.8cm x 12.5cm

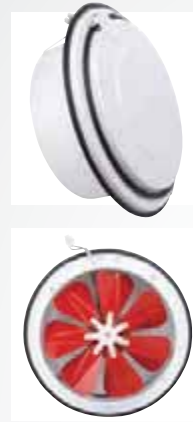

### HL 961

- 220-240V / 50-60Hz
- Air Flow: 780
- Speed: 1150
- Power Input: 40W
- Weight: 2,2kg
- Product Size: 27.5cm x 27.5cm x 12.5cm



### HL 962

- 220-240V / 50-60Hz
- Air Flow: 890
- Speed: 1100
- Power Input: 50W
- Weight: 2,4kg
- Product Size: 33.6cm x 33.6cm x 13cm





**NEW** HL 963



- 220-240V / 50-60Hz
- 12W
- Air Flow: 100m<sup>3</sup>/h
- Speed: 2250
- Noise Level: 51 dbA
- Hole Diameter: 10cm - 4"



**NEW** HL 964



- 220-240V / 50-60Hz
- 15W
- Air Flow: 150m<sup>3</sup>/h
- Speed: 1900
- Noise Level: 53 dbA
- Hole Diameter: 12cm - 5"



**NEW** HL 965



- 220-240V / 50-60Hz
- 20W
- Air Flow: 200m<sup>3</sup>/h
- Speed: 1800
- Noise Level: 56 dbA
- Hole Diameter: 15cm - 6"



# KaçmazGrup



HOROZ ELECTRIC & ELECTRONIC TRADE CO.



İREM ELECTRIC FOREIGN TRADE CO.



HOROZ ELECTRIC COMPANY & ARBIL IRAQ



TEB ELECTRIC INDUSTRY & TRADE CO.



MEDISTATE KAVACIK HOSPITAL



[www.horozelektrik.com](http://www.horozelektrik.com)

 **KaçmazGrup**